

**Applicable Model**

R20BX4

**Drawing Title**

Intercom Panel

**Drawing Unit**

mm

**Drawing Scale**

Not to scale

**DRAFT  
SUBJECT TO  
CHANGE**

**Last Revised**

Oct 09,2023

**Drawing Version**

V1.0

**Page**

1 of 10

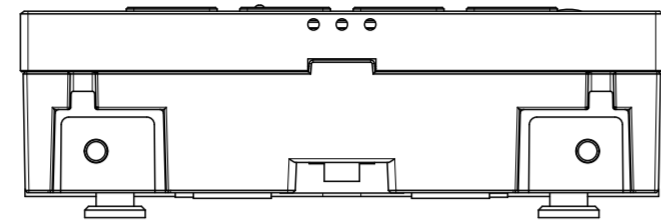

5 TOP VIEW

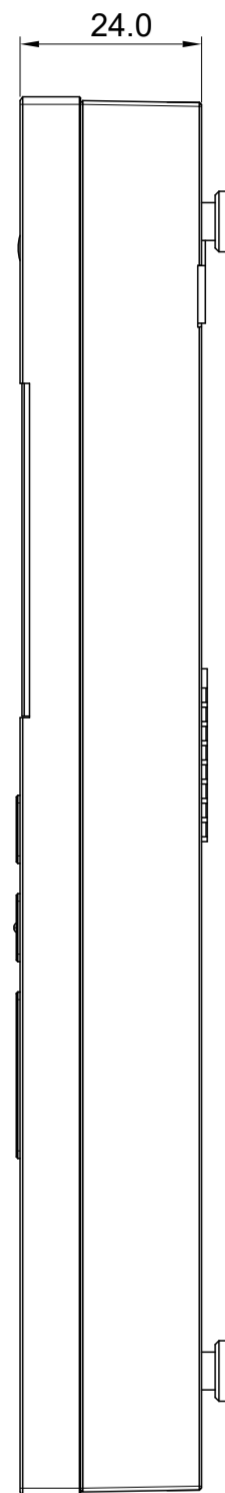

2 RIGHT VIEW

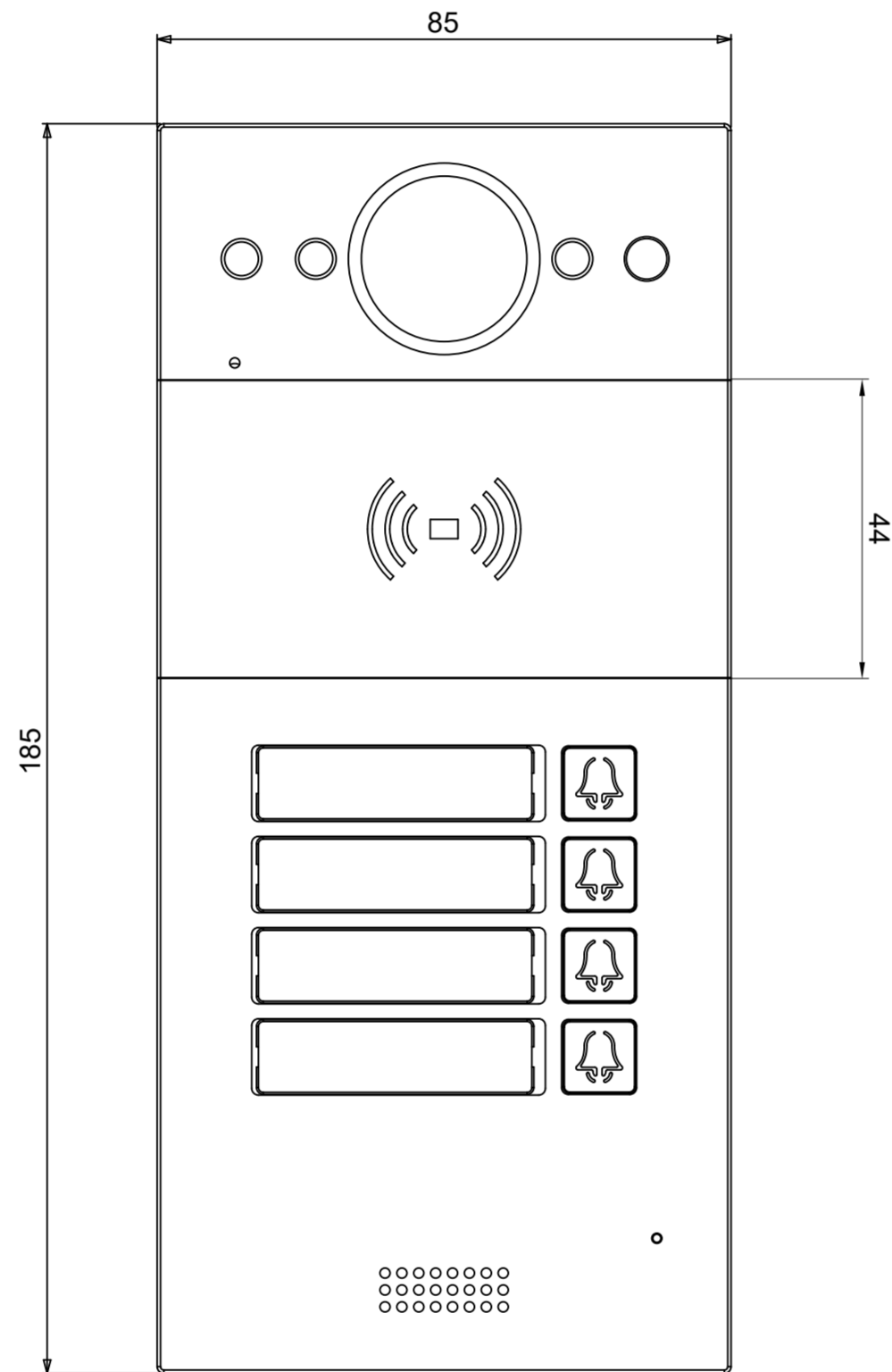

1 FRONT VIEW

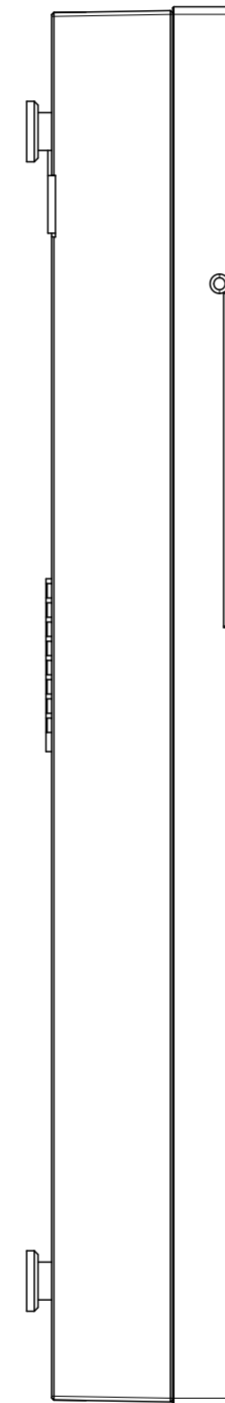

3 LEFT VIEW

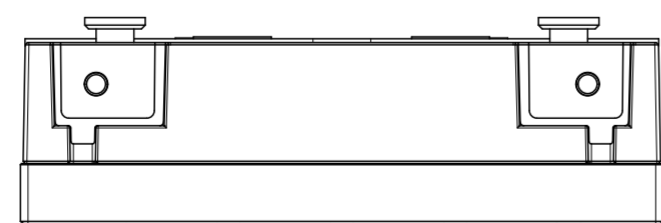

6 BOTTOM VIEW

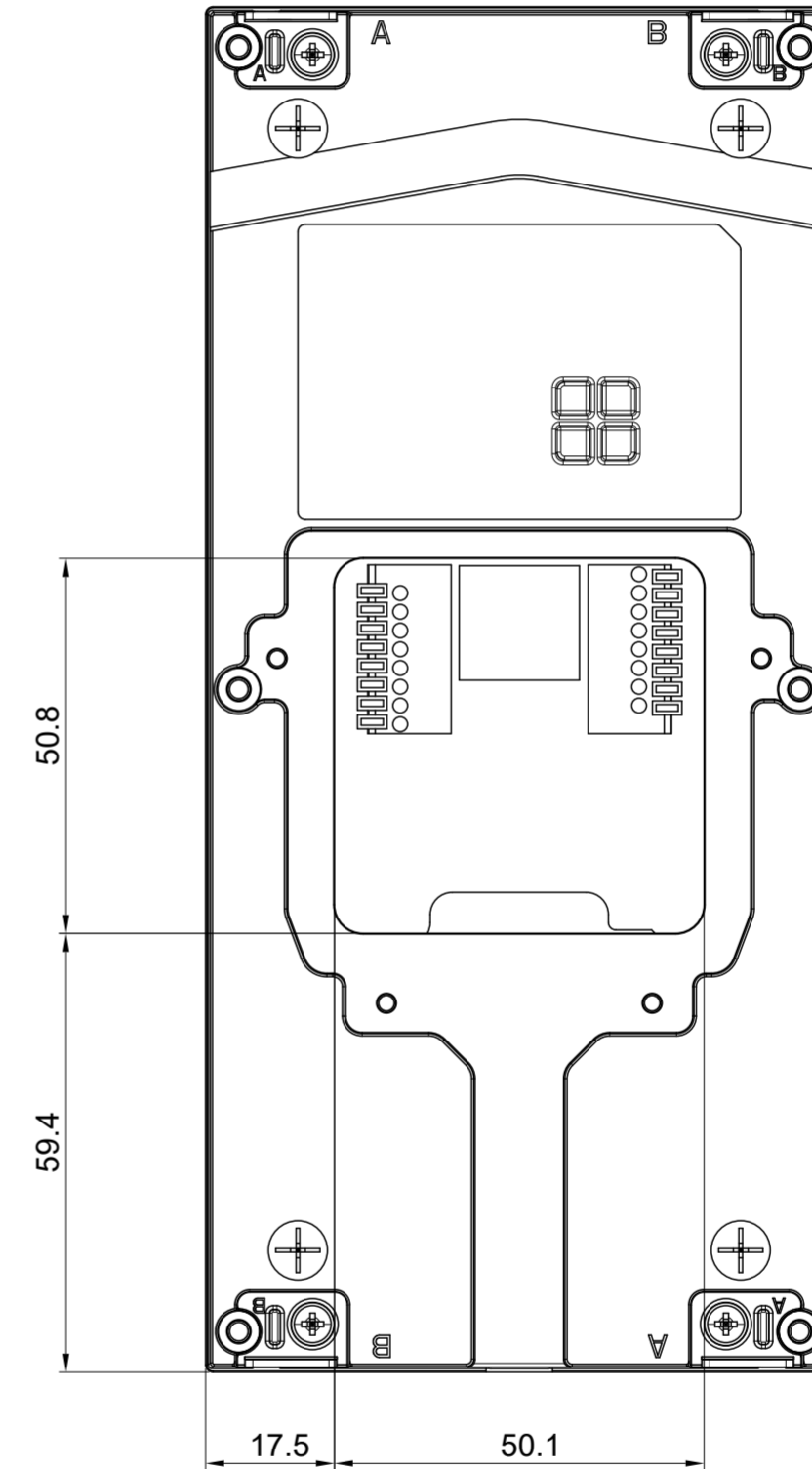

4 BACK VIEW

**Applicable Model**

R20B

**Drawing Title**

Wall Mounting Bracket

**Drawing Unit**

mm

**Drawing Scale**

Not to scale

**DRAFT  
SUBJECT TO  
CHANGE**

**Last Revised**

Oct 09, 2023

**Drawing Version**

V1.0

**Page**

2 of 10

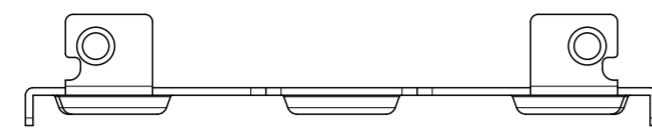

5 TOP VIEW

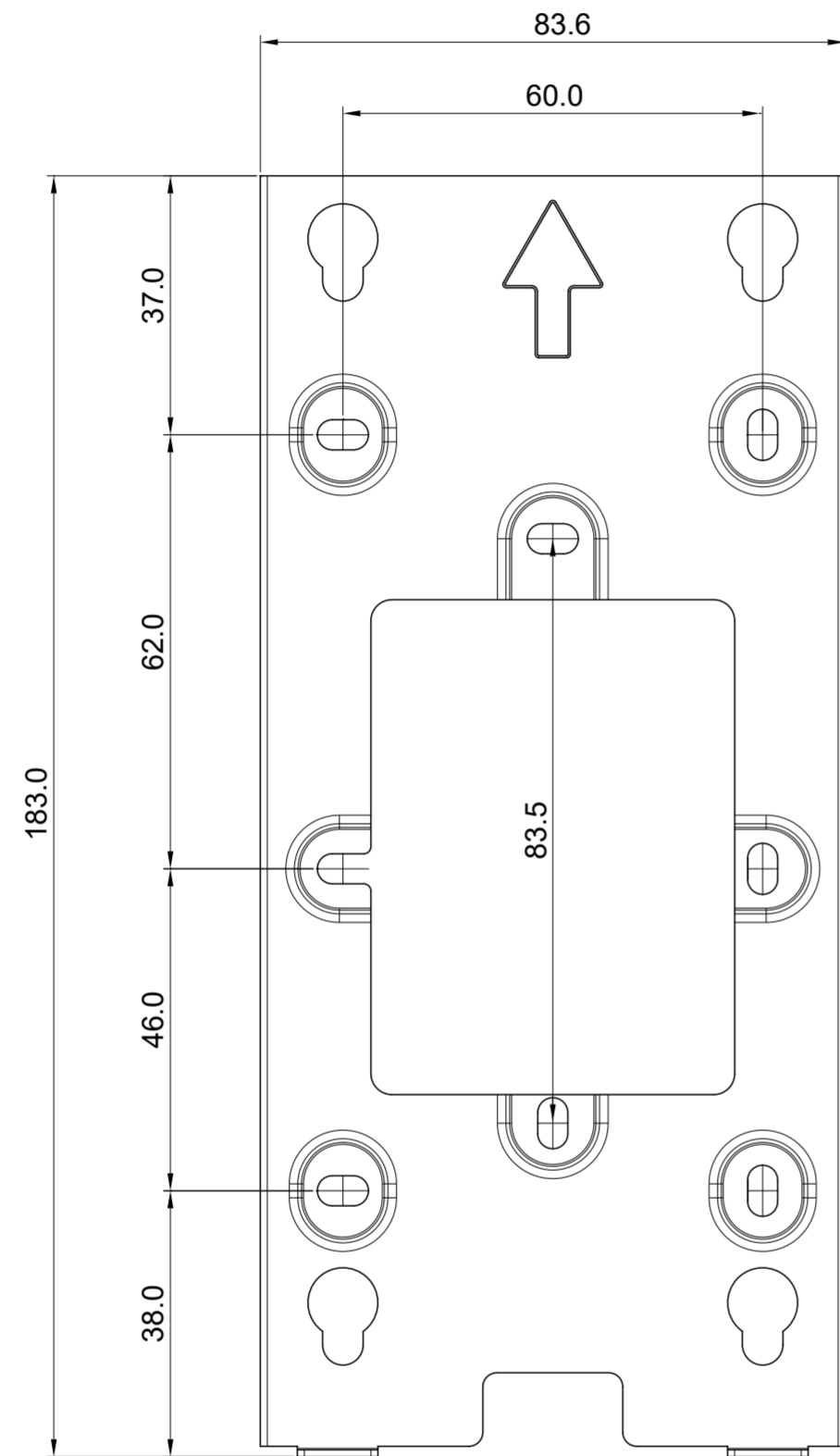

1 FRONT VIEW

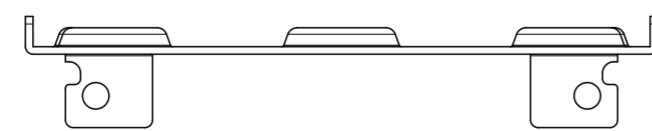

6 BOTTOM VIEW

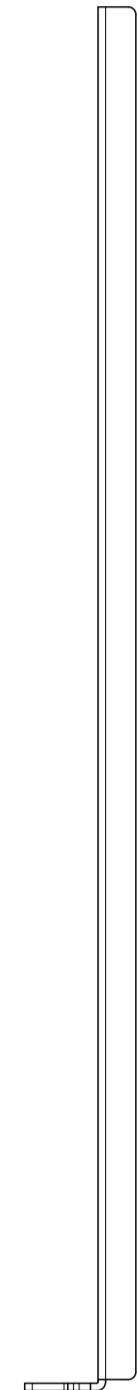

2 RIGHT VIEW

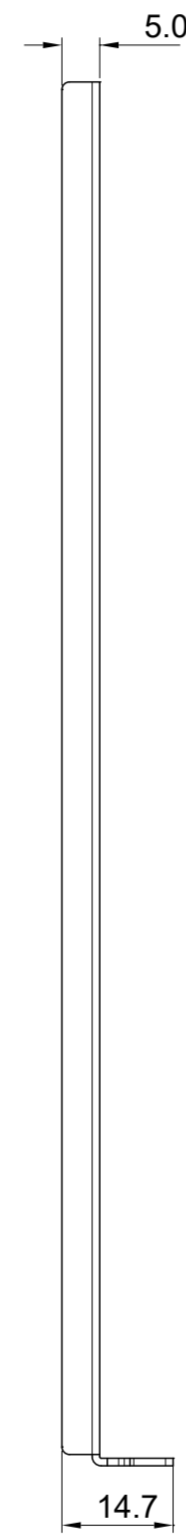

3 LEFT VIEW

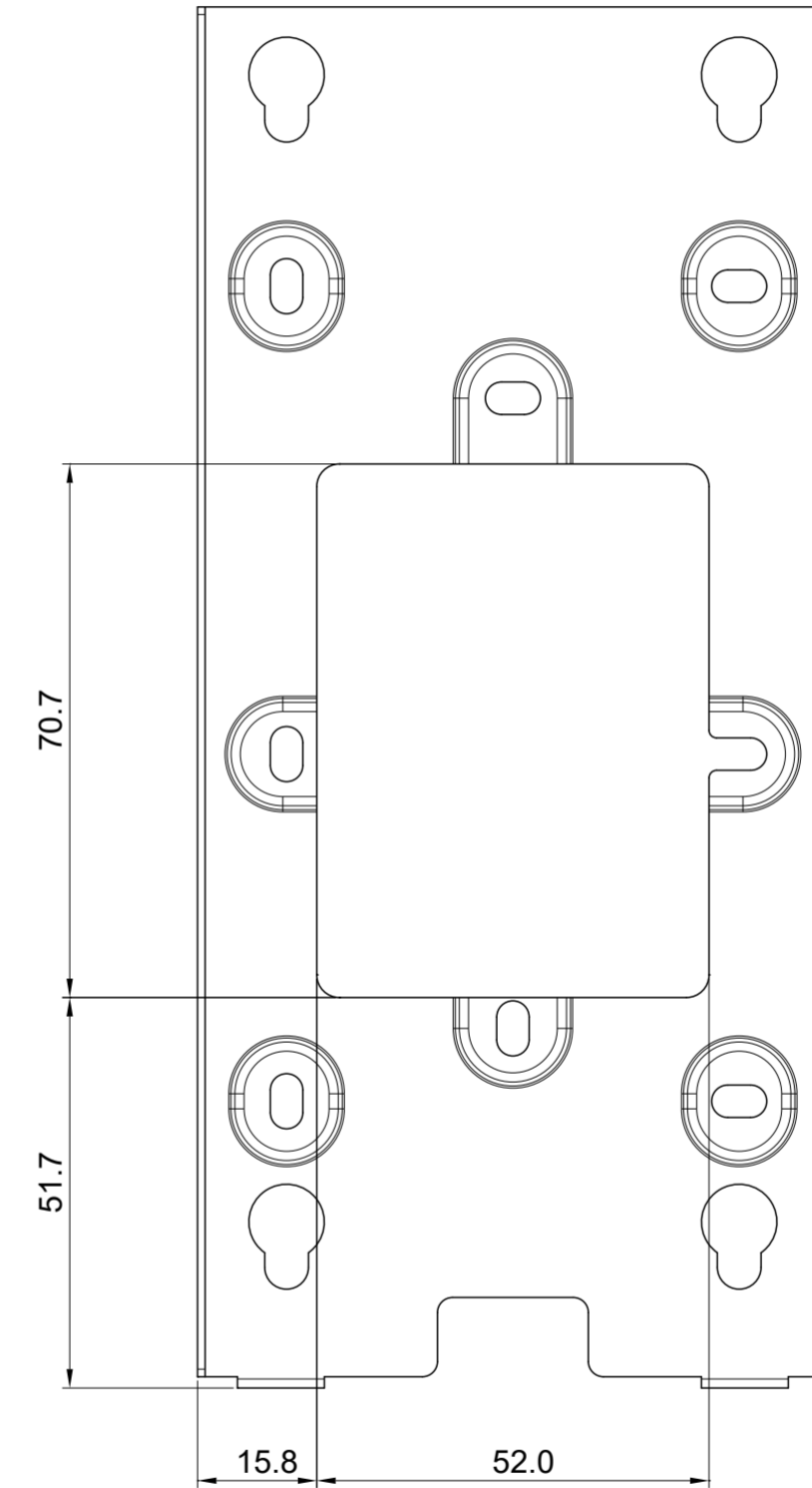

4 BACK VIEW

**Applicable Model**

R20BX4

**Drawing Title**

Placement

**Drawing Unit**

mm

**Drawing Scale**

Not to scale

**DRAFT  
SUBJECT TO  
CHANGE**

**Last Revised**

Oct 09,2023

**Drawing Version**

V1.0

**Page**

3 of 10

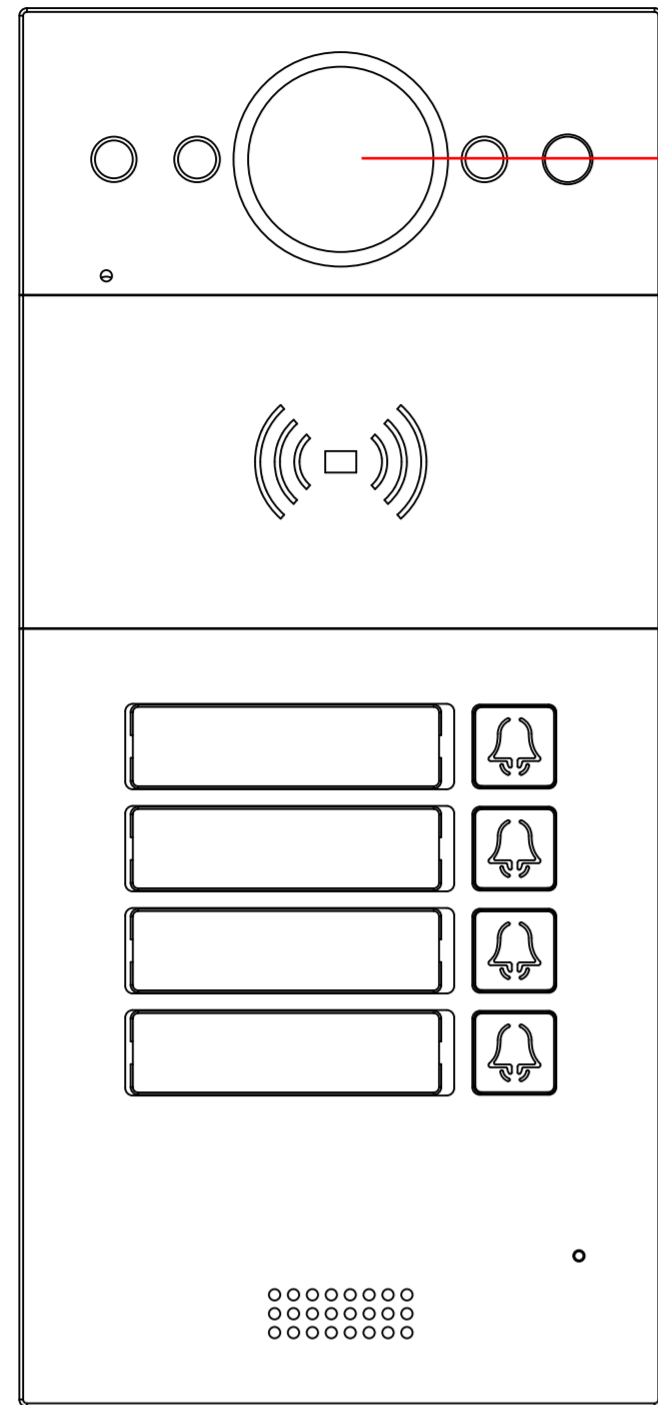

1 INTERCOM PANEL FRONT VIEW

1235mm TO BOTTOM OF PANEL

1400mm TO CENTER OF CAMERA

ADA Compliance Requirement

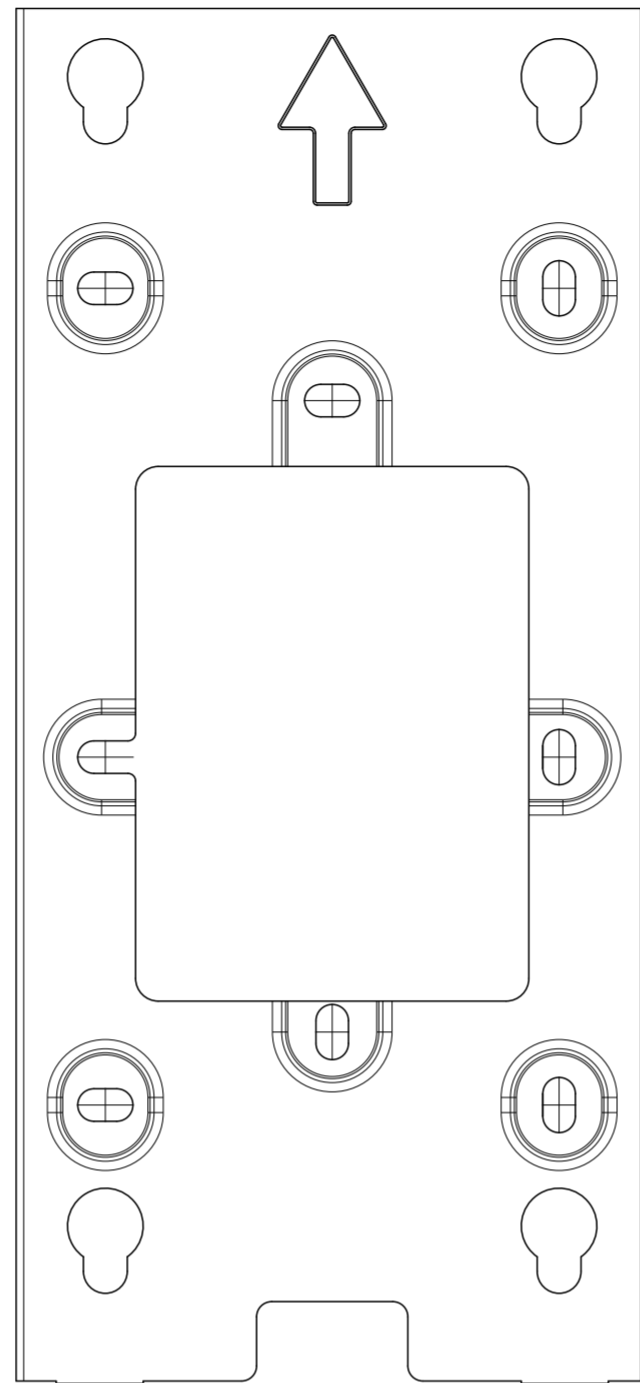

2 FRONT VIEW:WALL MOUNTING BRACKET PLACEMENT

1235mm TO BOTTOM OF BRACKET

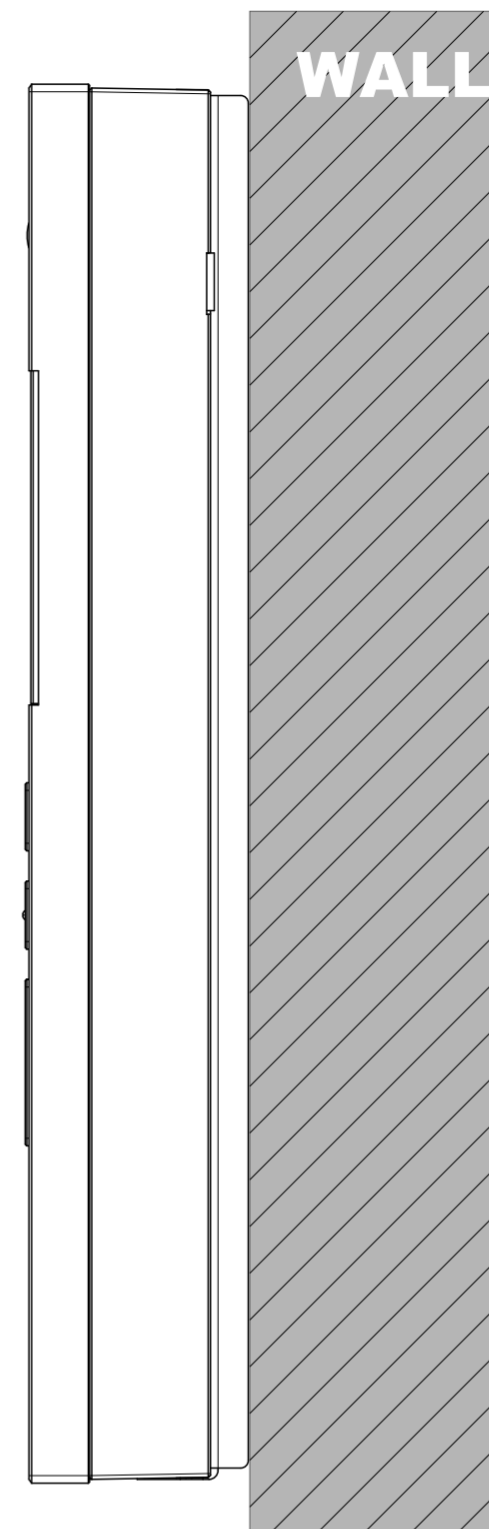
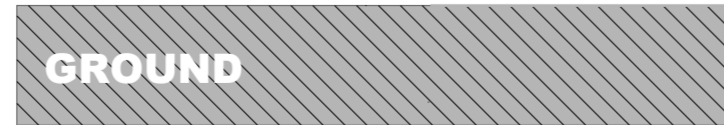

3 SIDE VIEW:INTERCOM PANEL ON WALL

WALL

**Applicable Model**

R20B

**Drawing Title**

On-Wall Mounting  
Rain Cover

**Drawing Unit**

mm

**Drawing Scale**

Not to scale

**DRAFT  
SUBJECT TO  
CHANGE**

**Last Revised**

Oct 09, 2023

**Drawing Version**

V1.0

**Page**

4 of 10

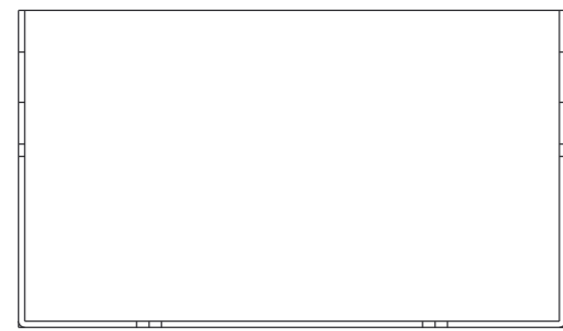

⑥ **BOTTOM VIEW**

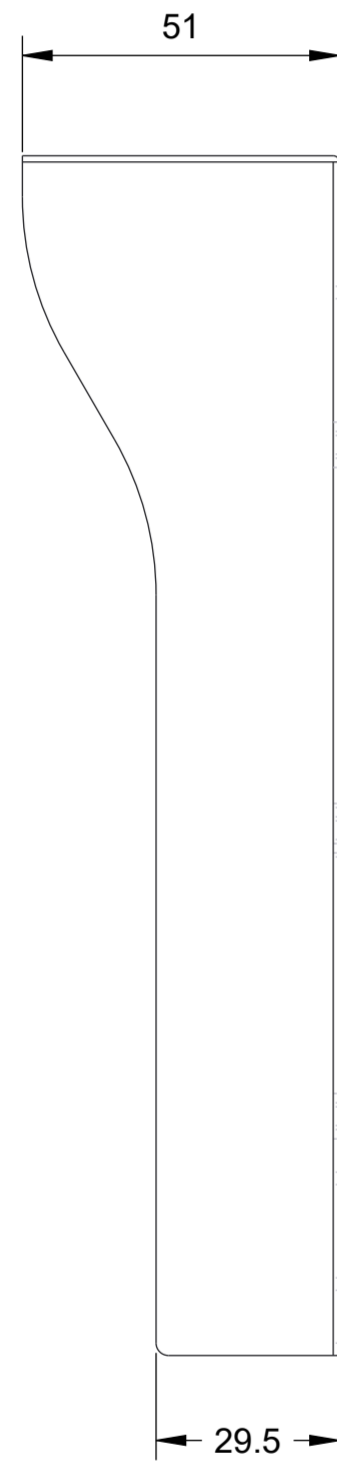

② **RIGHT VIEW**

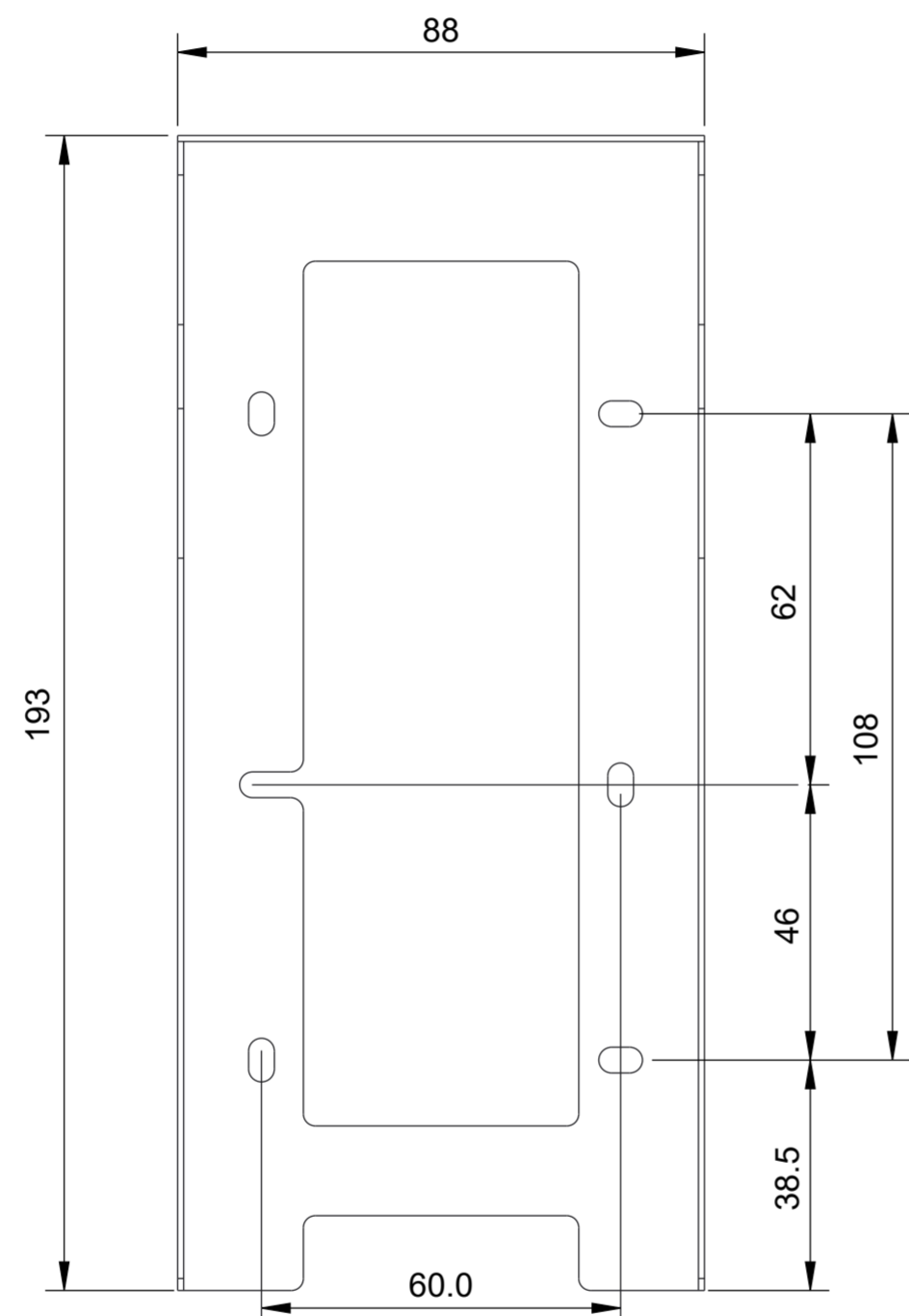

① **FRONT VIEW**

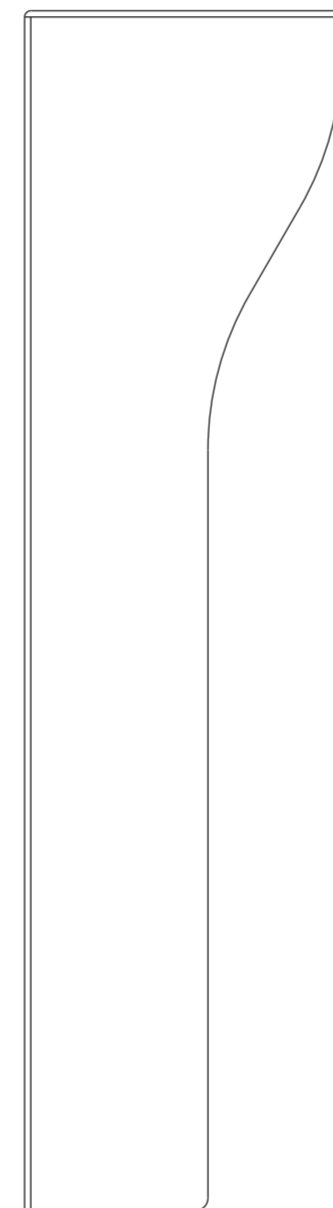

③ **LEFT VIEW**

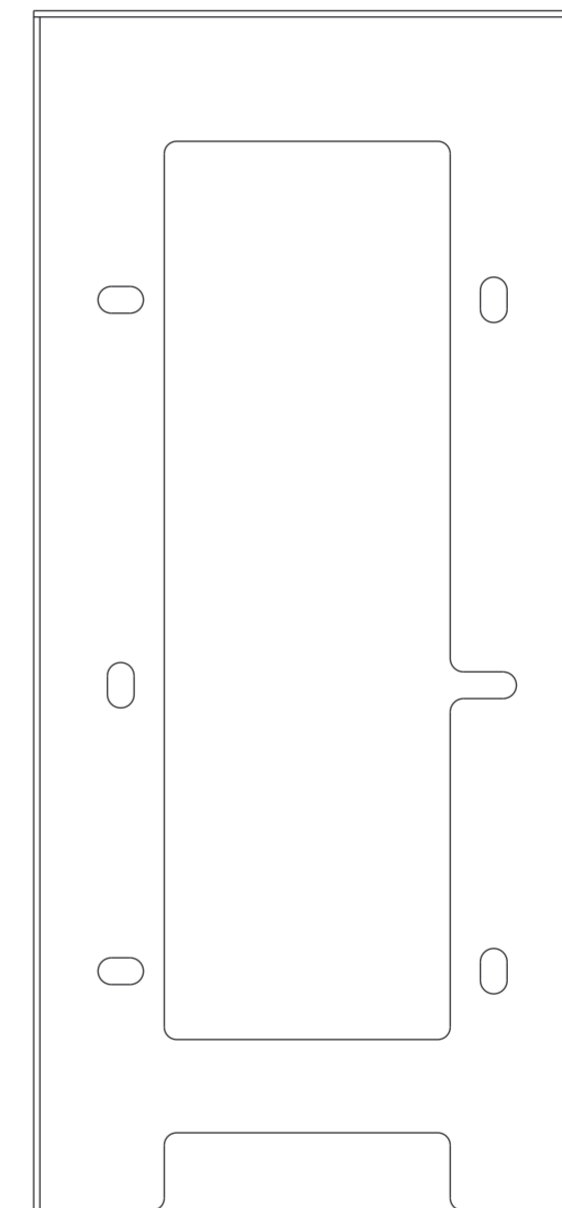

④ **BACK VIEW**



⑤ **TOP VIEW**

**Applicable Model**

R20BX4

**Drawing Title**

Placement

**Drawing Unit**

mm

**Drawing Scale**

Not to scale

**DRAFT  
SUBJECT TO  
CHANGE**

**Last Revised**

Oct 09,2023

**Drawing Version**

V1.0

**Page**

5 of 10

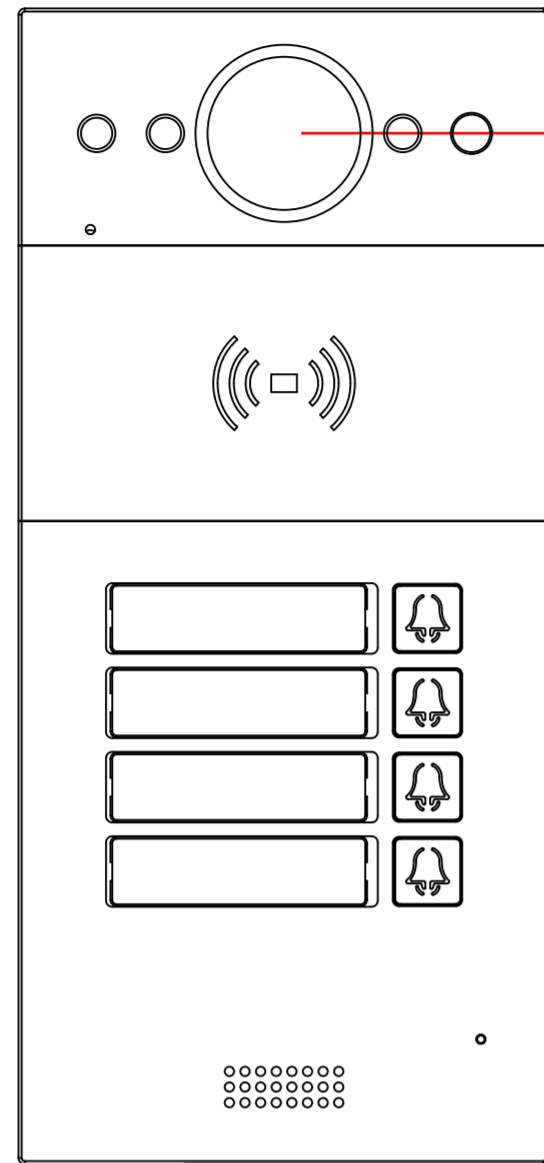

① INTERCOM PANEL FRONT VIEW

1235mm TO BOTTOM OF PANEL

1400mm TO CENTER OF CAMERA

ADA Compliance Requirement

GROUND

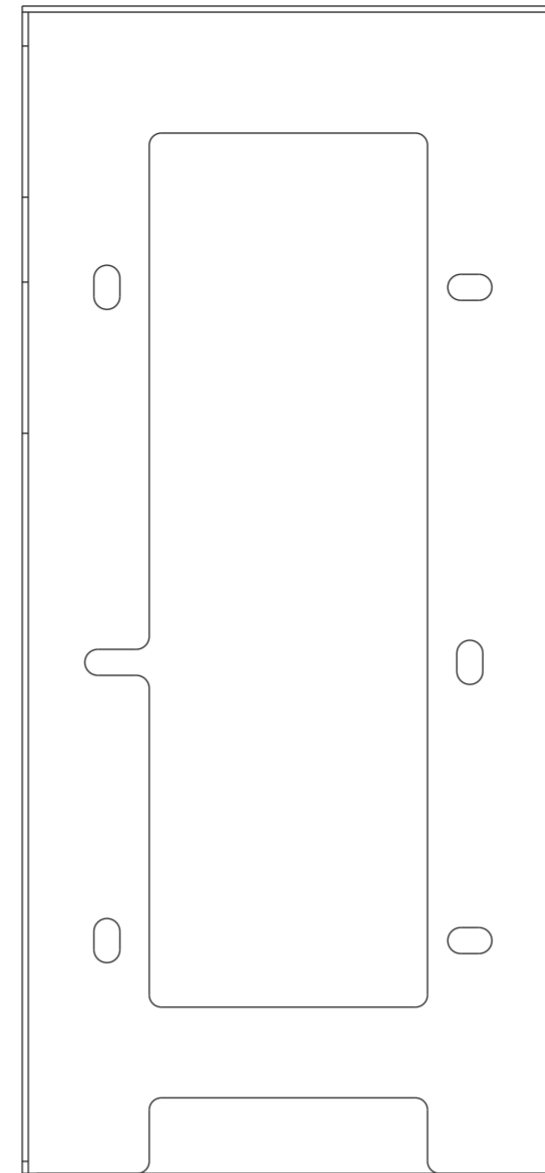

② FRONT VIEW:WALL MOUNTING BRACKET PLACEMENT

1235mm TO BOTTOM OF BRACKET

GROUND

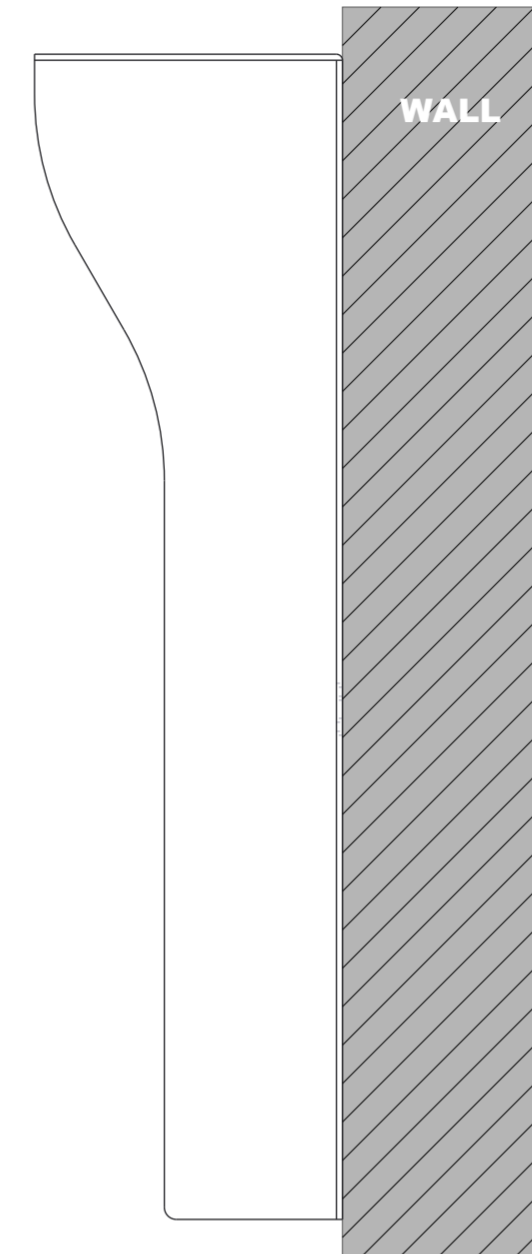

③ SIDE VIEW:INTERCOM PANEL ON WALL

**Applicable Model**

R20B

**Drawing Title**

Decorative Panel

**Drawing Unit**

mm

**Drawing Scale**

Not to scale

**DRAFT  
SUBJECT TO  
CHANGE**

**Last Revised**

Oct 09,2023

**Drawing Version**

V1.0

**Page**

6 of 10

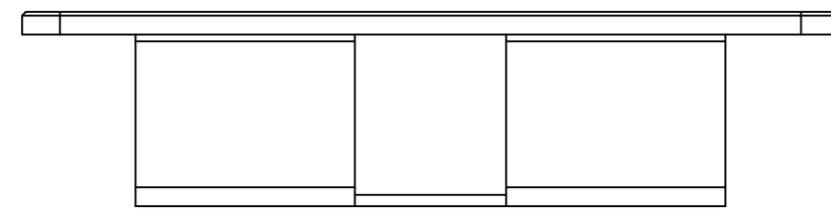

5 TOP VIEW

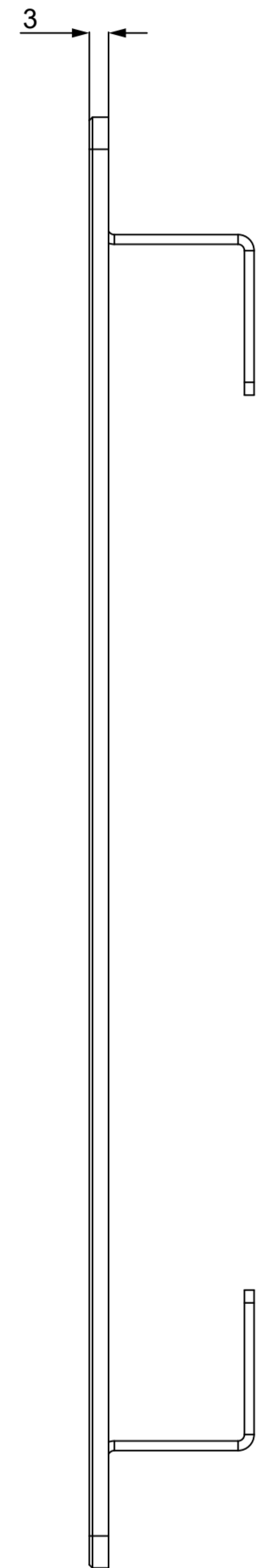

2 RIGHT VIEW

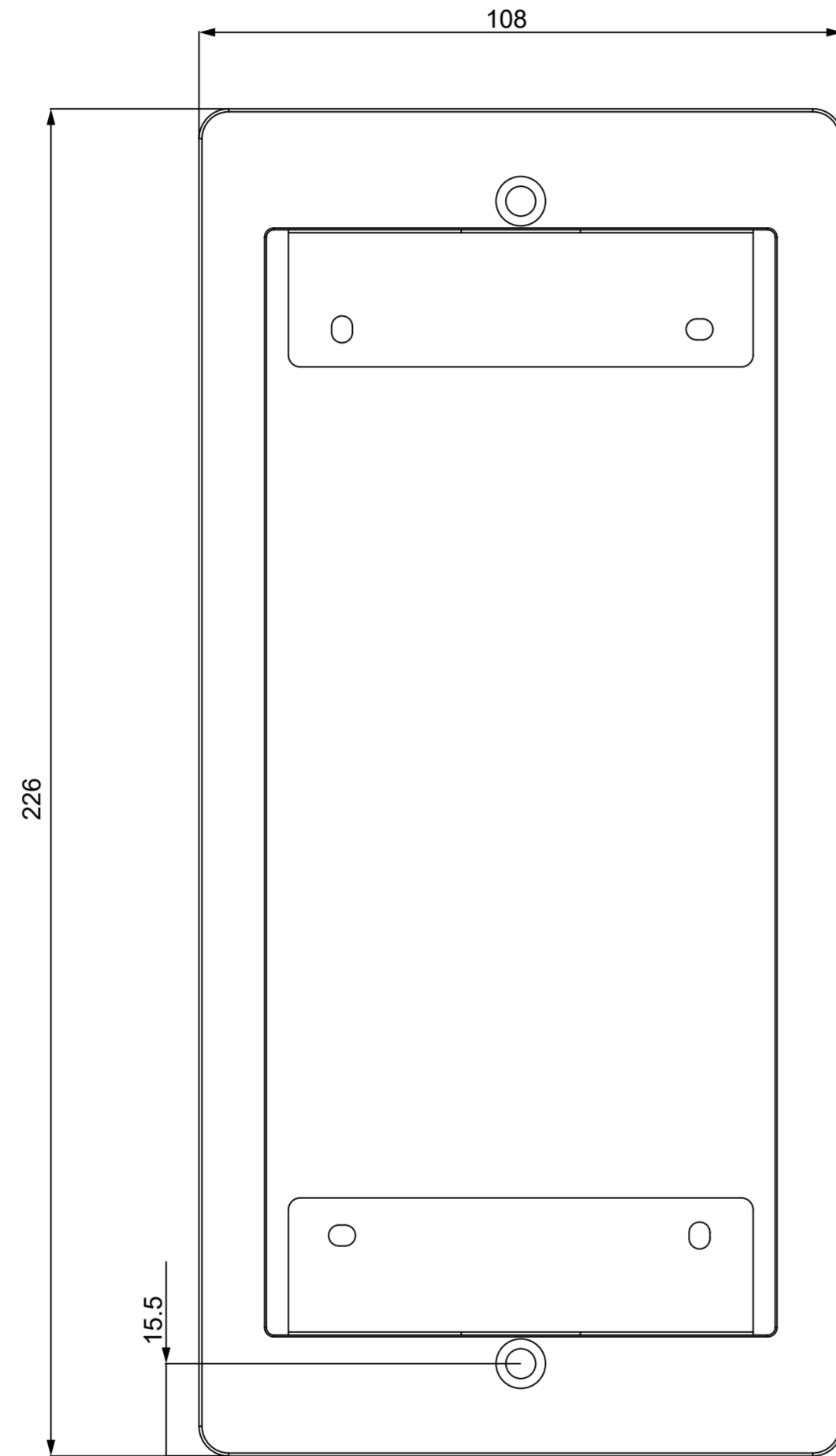

1 FRONT VIEW

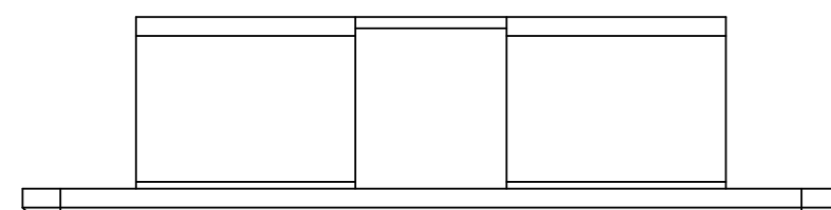

6 BOTTOM VIEW

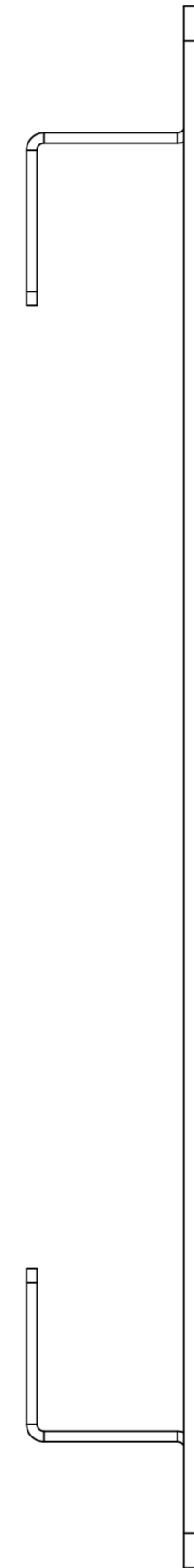

3 LEFT VIEW

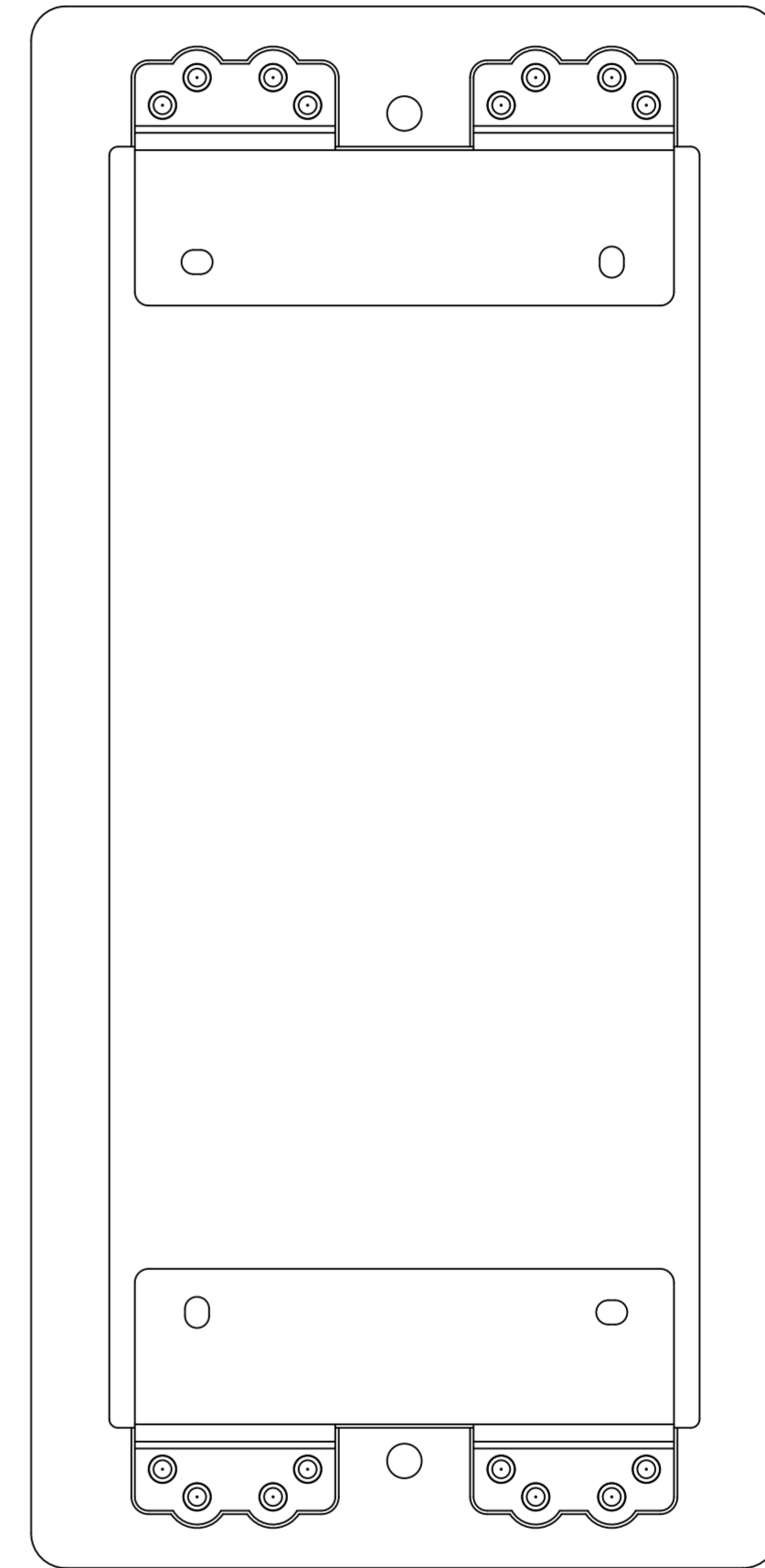

4 BACK VIEW

**Applicable Model**

R20B

**Drawing Title**

Flush Mounting Box

**Drawing Unit**

mm

**Drawing Scale**

Not to scale

**DRAFT  
SUBJECT TO  
CHANGE**

**Last Revised**

Oct 09,2023

**Drawing Version**

V1.0

**Page**

7 of 10

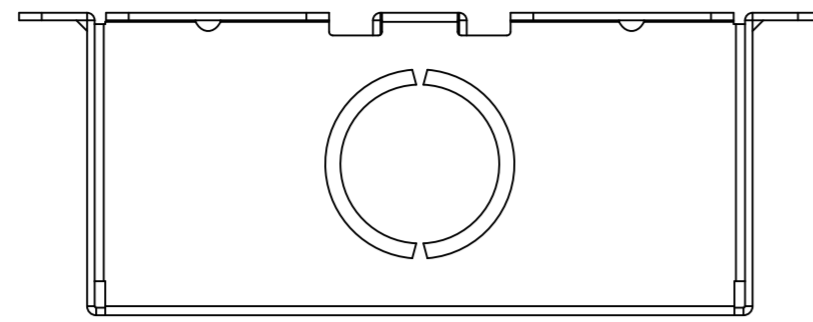

5 TOP VIEW

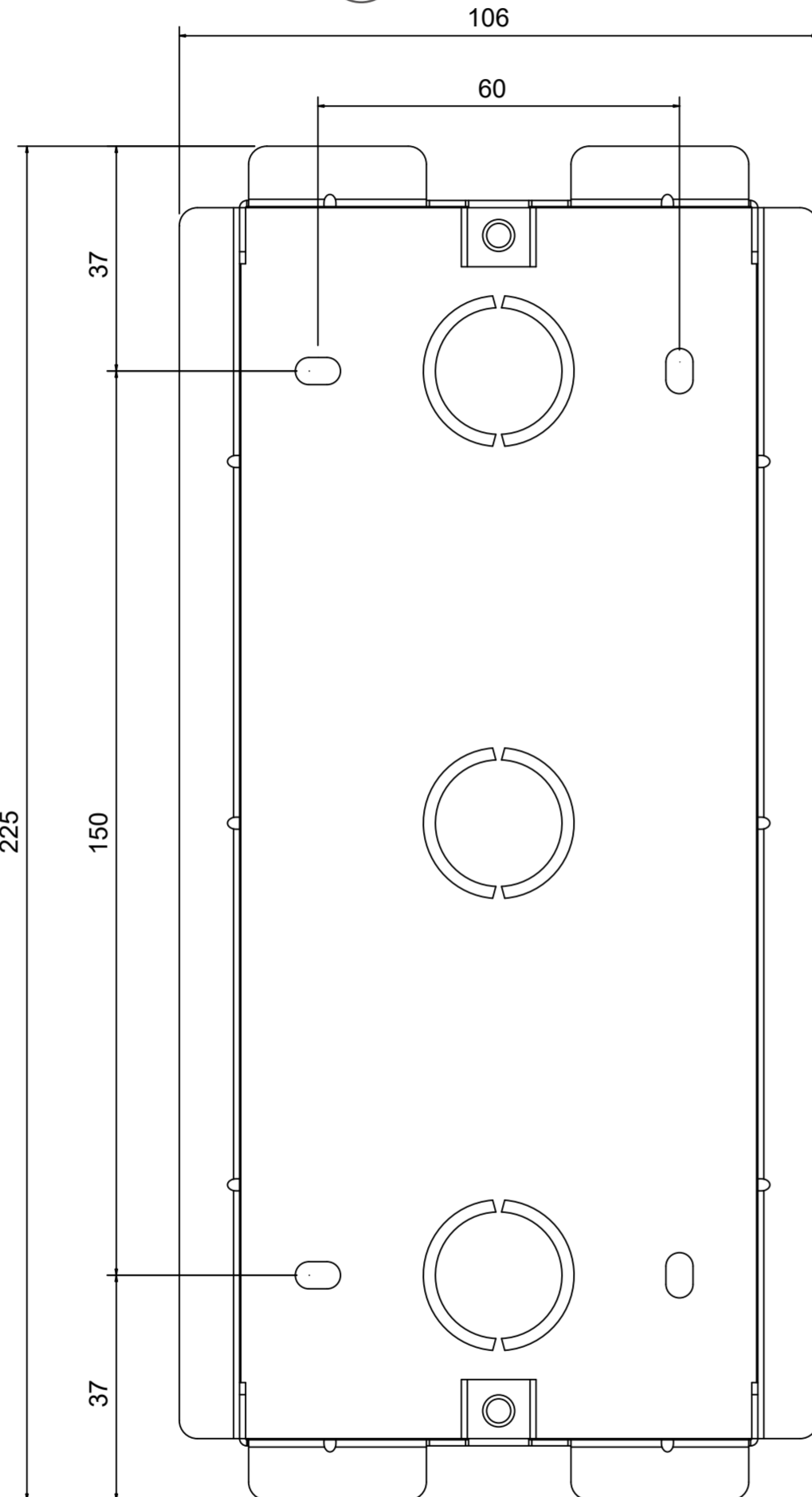

1 FRONT VIEW

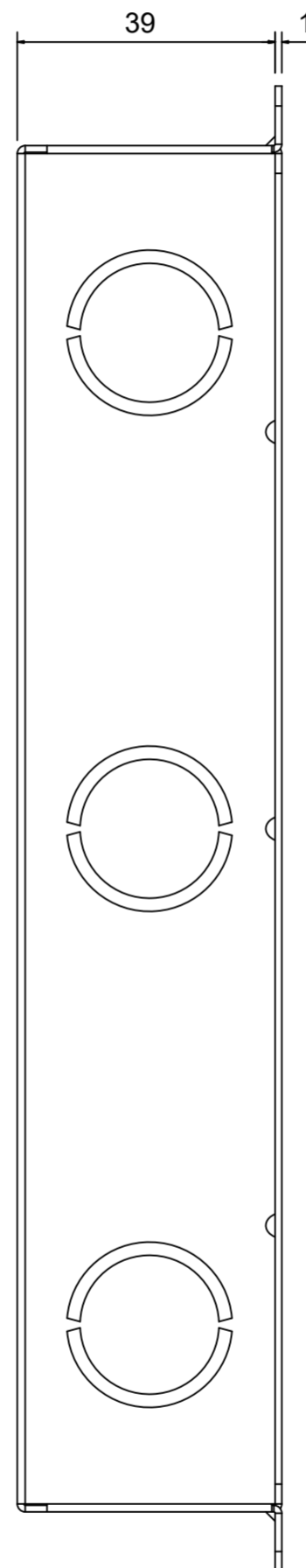

3 LEFT VIEW

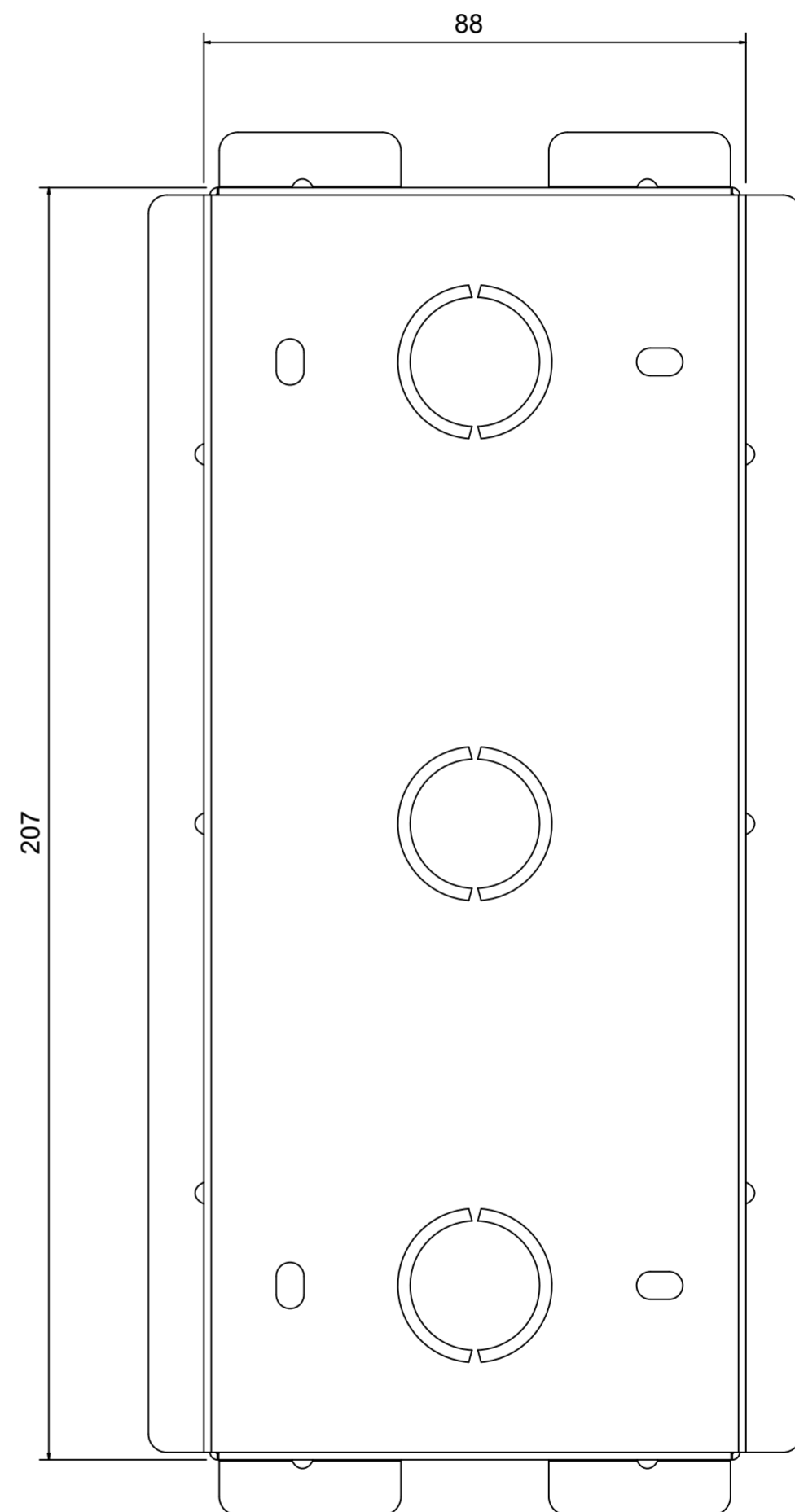

4 BACK VIEW

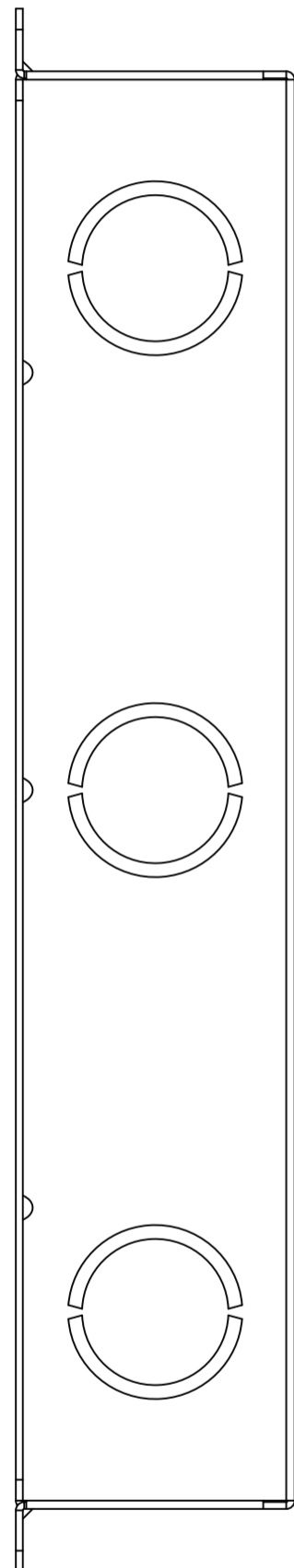

2 RIGHT VIEW

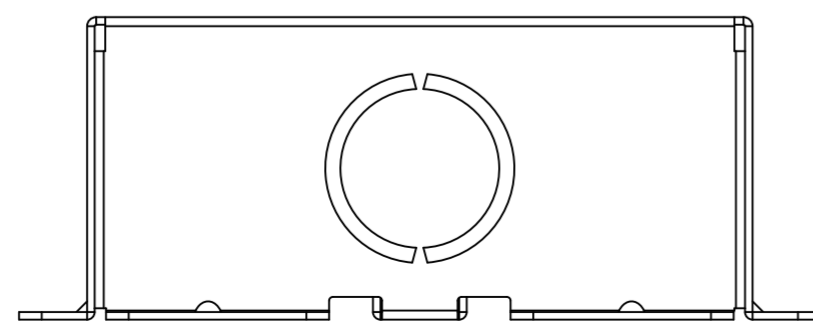

6 BOTTOM VIEW

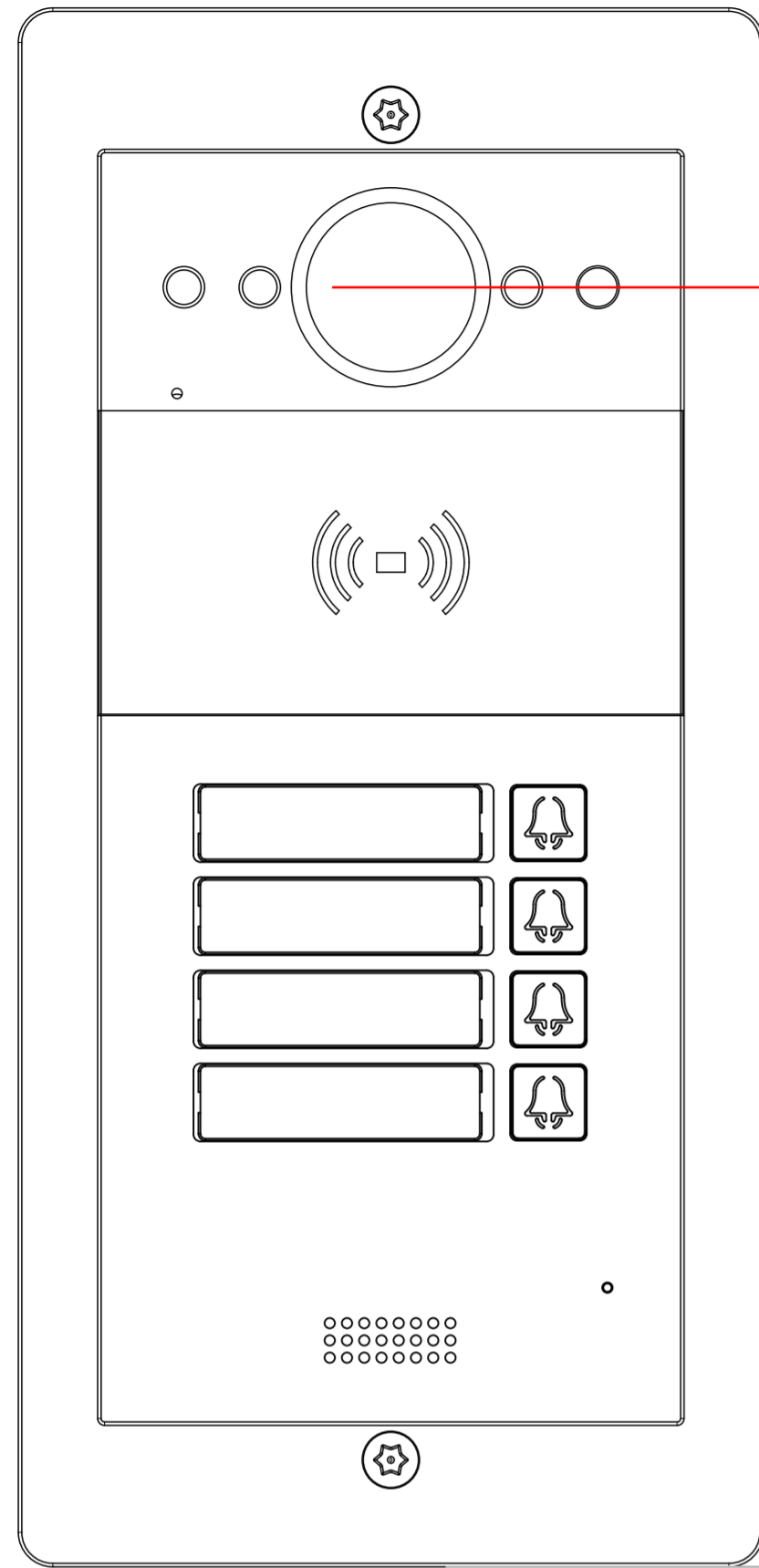

1 INTERCOM PANEL FRONT VIEW

1214.5mm TO BOTTOM OF BRACKET

1400mm TO CENTER OF CAMERA

ADA Compliance Requirement

GROUND

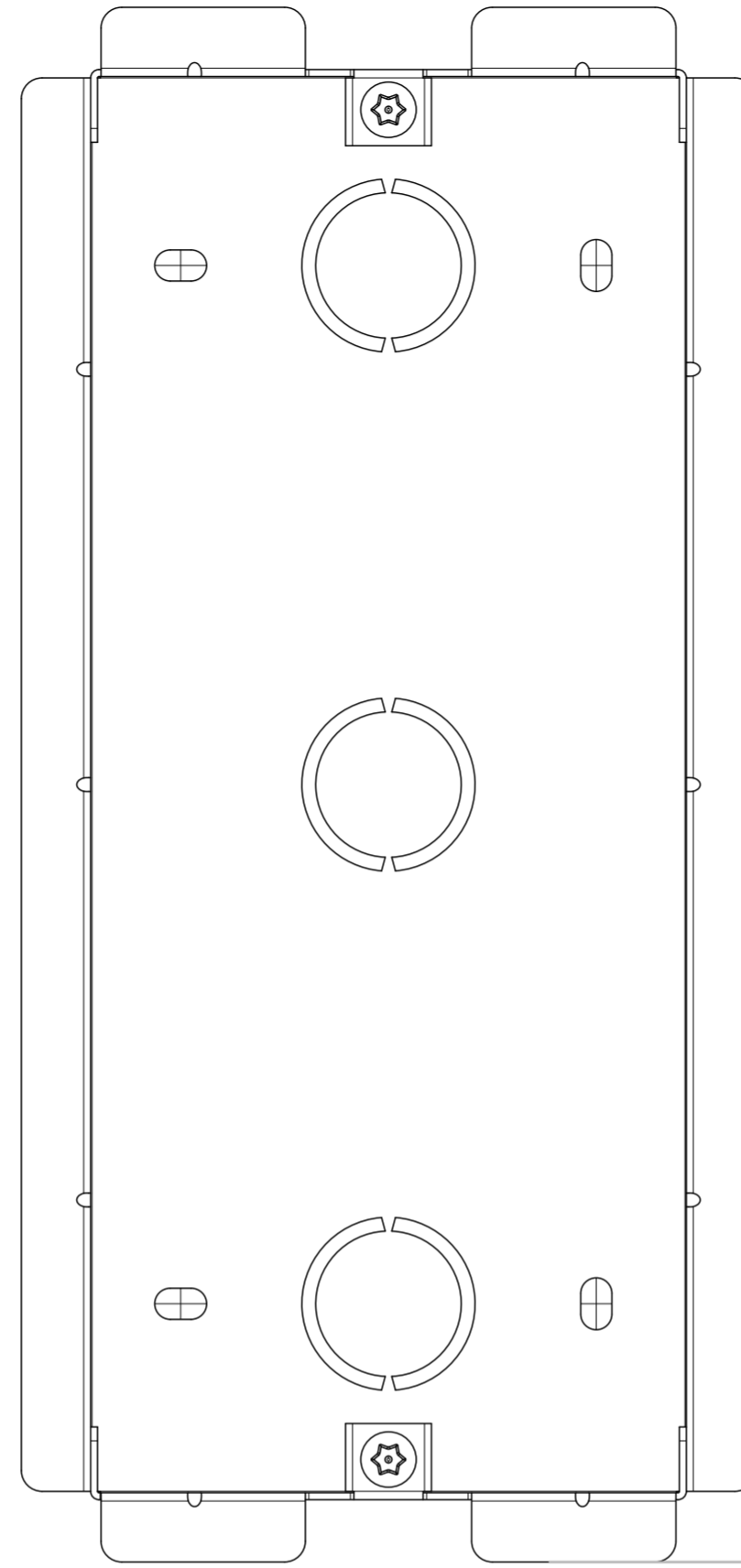

2 FRONT VIEW: FLUSHING MOUNTING BOX PLACEMENT

1215mm TO BOTTOM OF BRACKET

GROUND

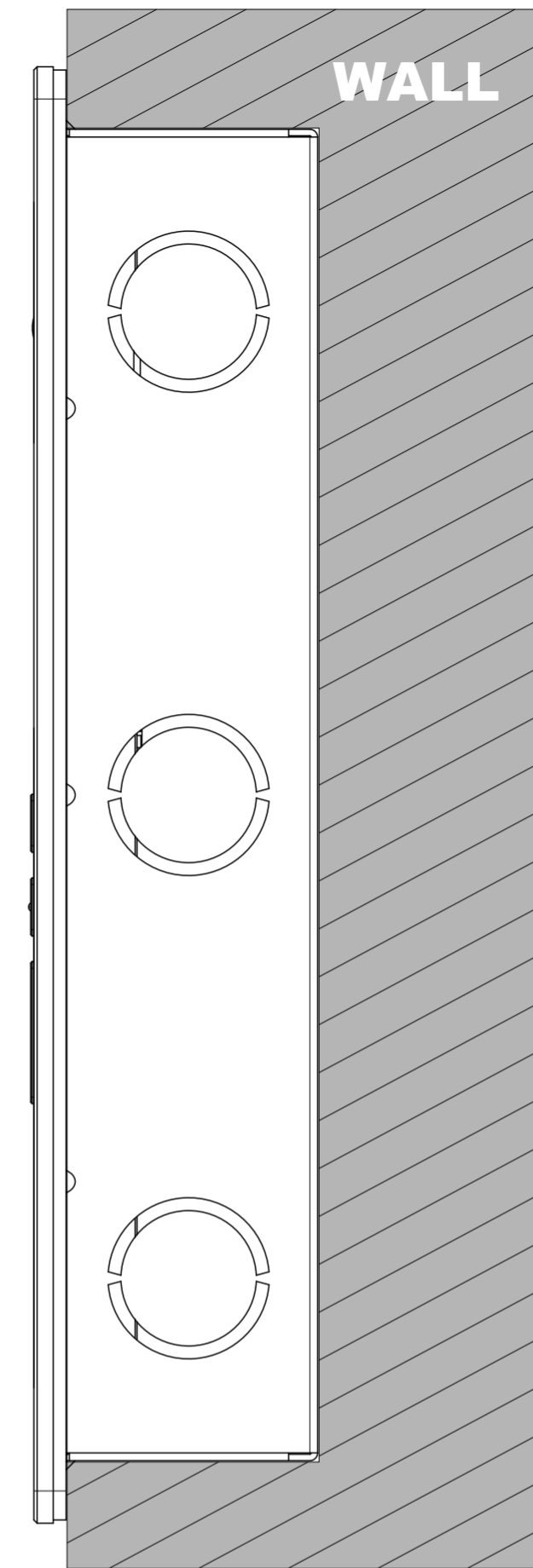

3 SIDE VIEW: INTERCOM PANEL IN WALL

**Applicable Model**

R20BX4

**Drawing Title**

Placement

**Drawing Unit**

mm

**Drawing Scale**

Not to scale

**DRAFT  
SUBJECT TO  
CHANGE**

**Last Revised**

Oct 09,2023

**Drawing Version**

V1.0

**Page**

8 of 10



**Applicable Model**

R20B

**Drawing Title**

In-Wall Mounting  
Rain Cover

**Drawing Unit**

mm

**Drawing Scale**

Not to scale

**DRAFT  
SUBJECT TO  
CHANGE**

**Last Revised**

Oct 09,2023

**Drawing Version**

V1.0

**Page**

9 of 10

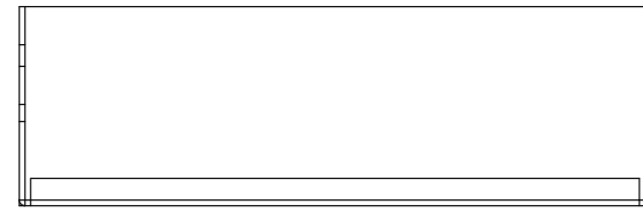

⑥ **BOTTOM VIEW**

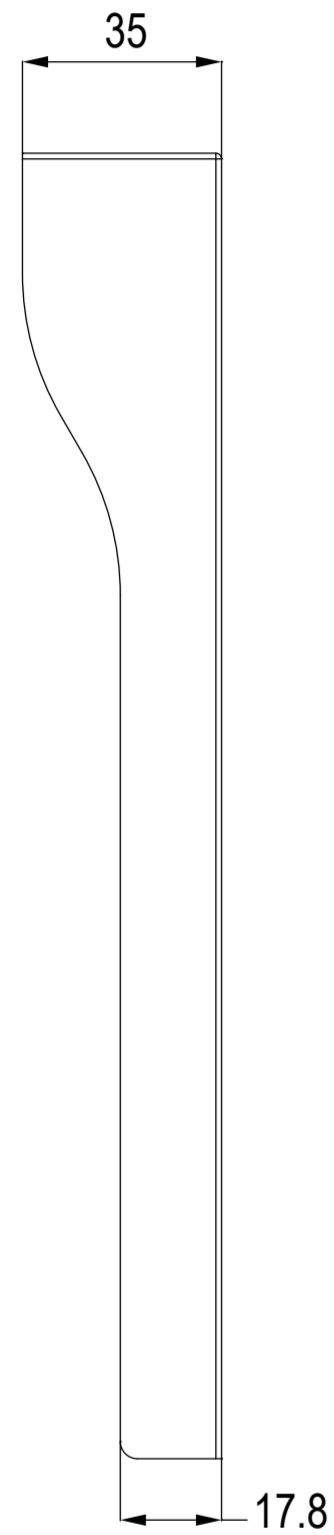

② **RIGHT VIEW**

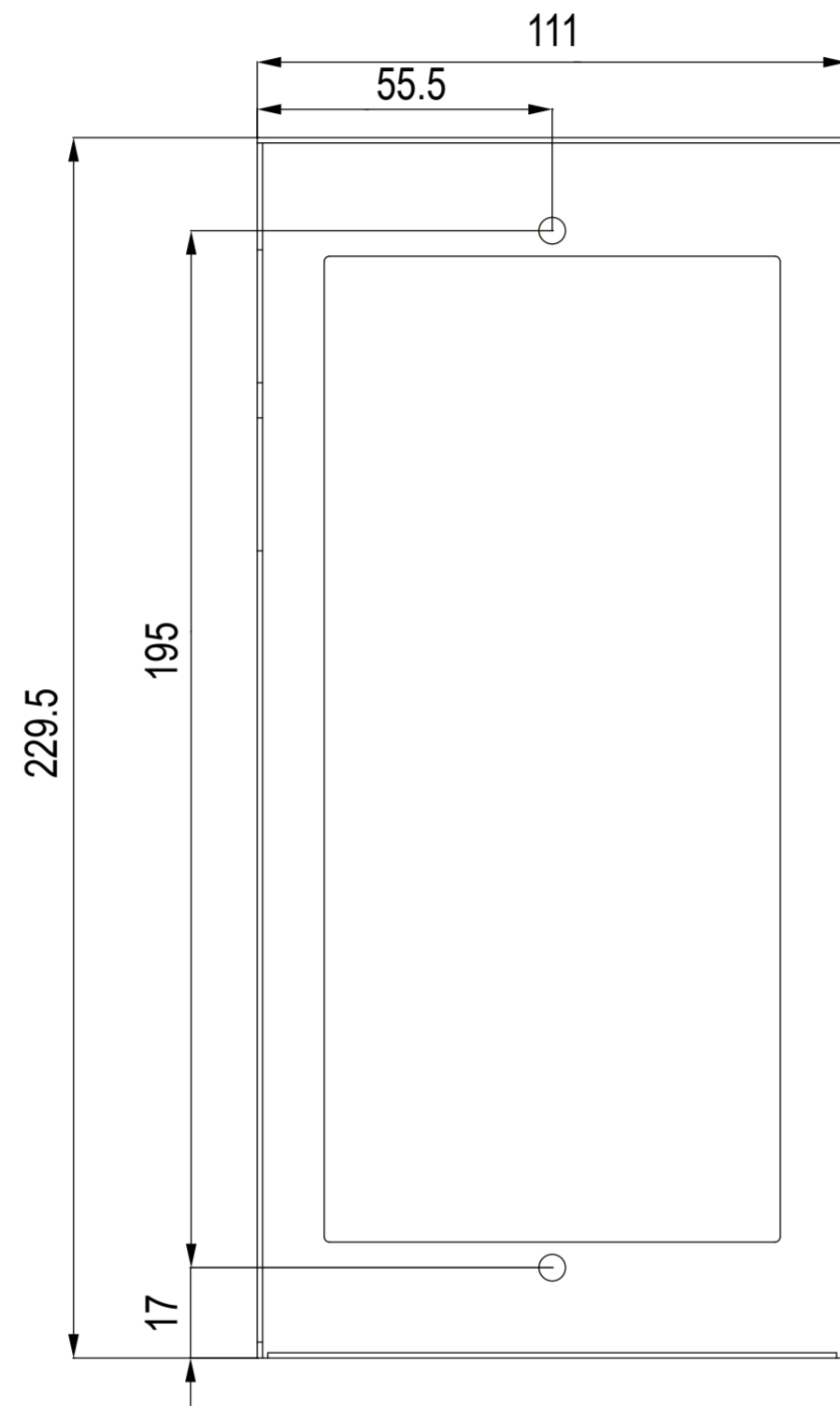

① **FRONT VIEW**

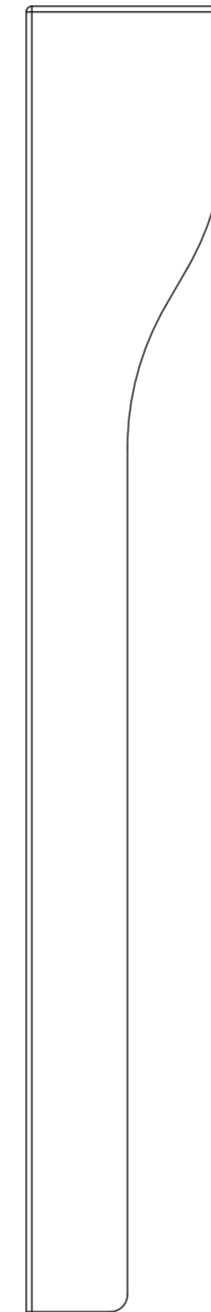

③ **LEFT VIEW**

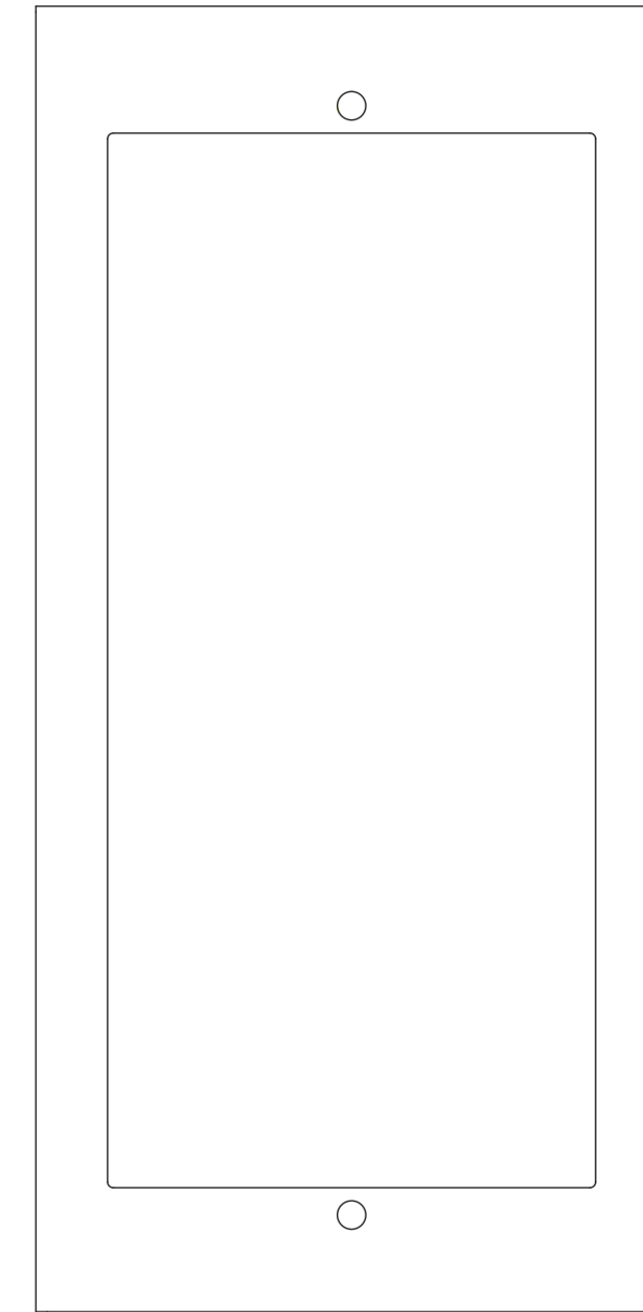

④ **BACK VIEW**



⑤ **TOP VIEW**

**Applicable Model**

R20BX4

**Drawing Title**

Placement

**Drawing Unit**

mm

**Drawing Scale**

Not to scale

**DRAFT  
SUBJECT TO  
CHANGE**

**Last Revised**

Oct 09,2023

**Drawing Version**

V1.0

**Page**

10 of 10

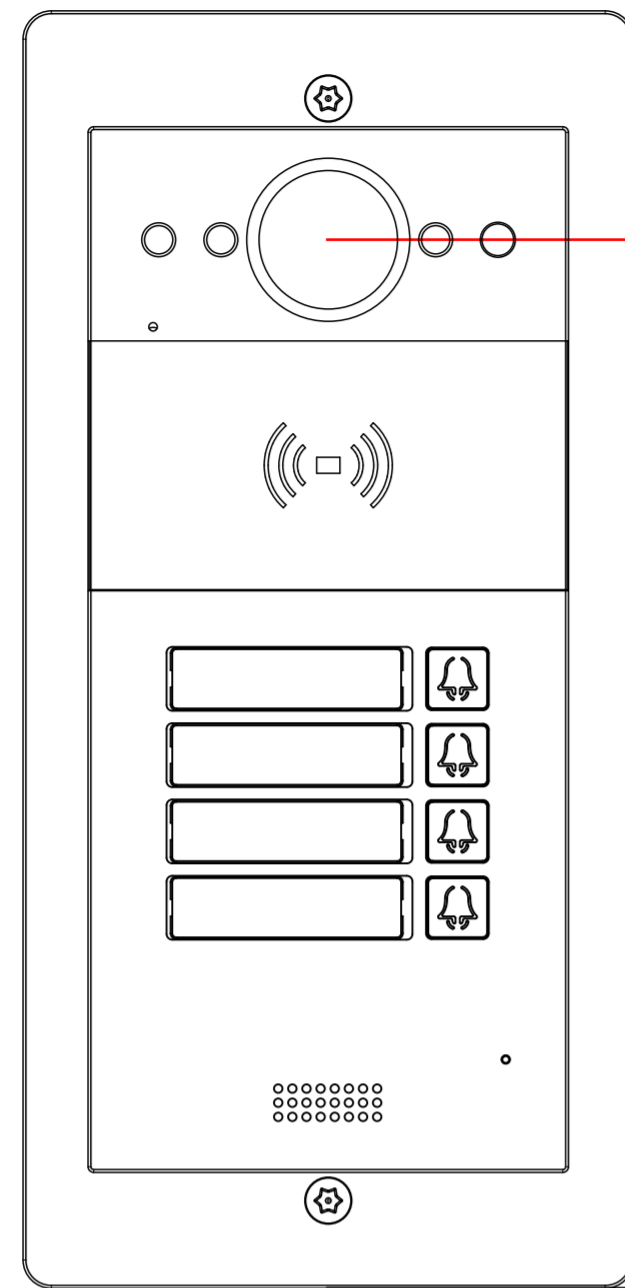

① INTERCOM PANEL FRONT VIEW

1214.5mm TO BOTTOM OF BRACKET

1400mm TO CENTER OF CAMERA

**ADA Compliance Requirement**

**GROUND**

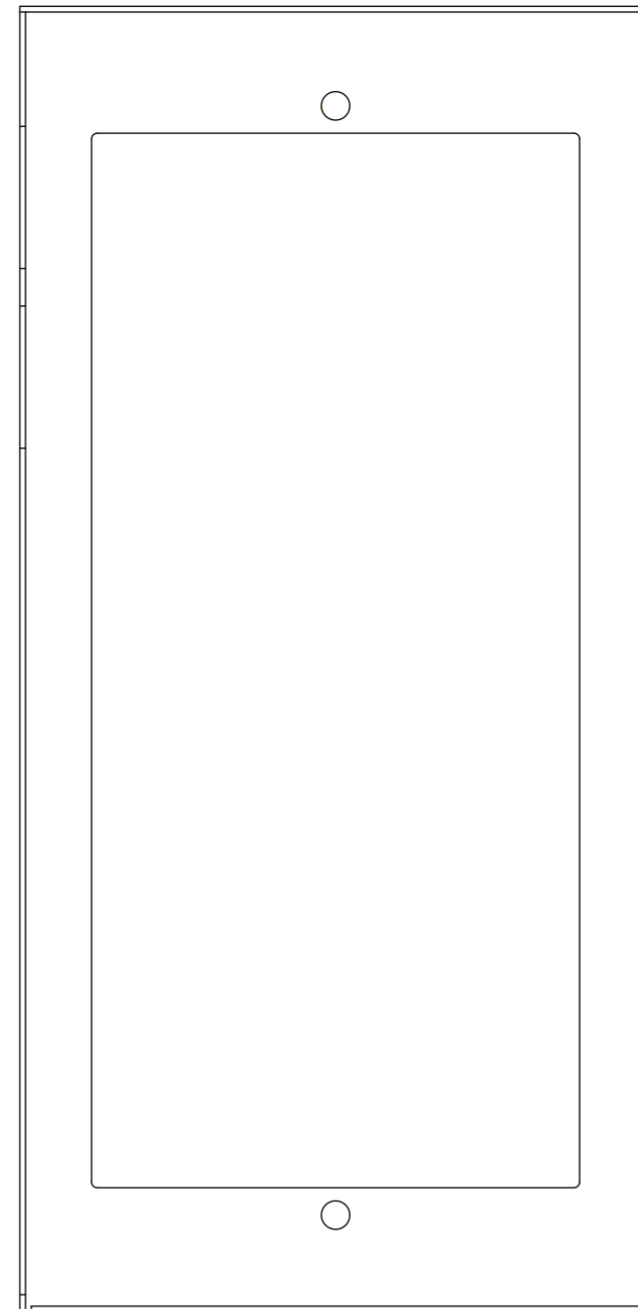

② FRONT VIEW:WALL MOUNTING BRACKET PLACEMENT

1213mm TO BOTTOM OF BRACKET

**GROUND**

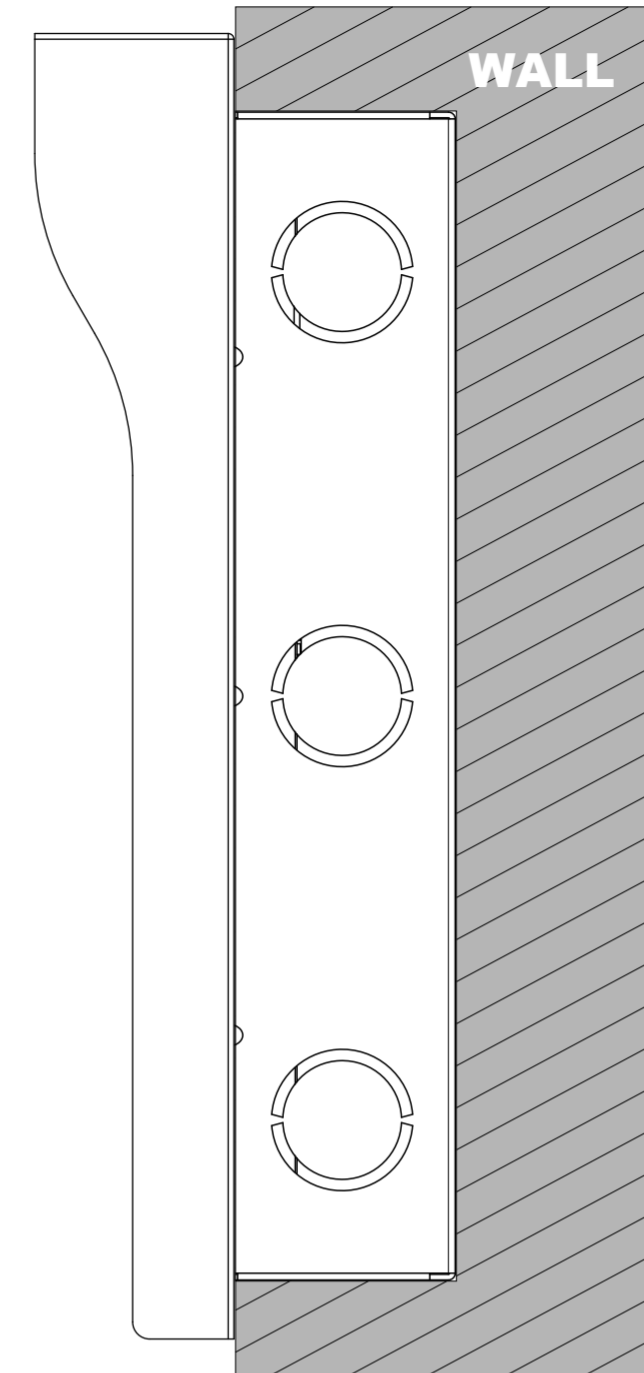

③ SIDE VIEW:INTERCOM PANEL IN WALL