

Applicable Model

R20BX5

Drawing Title

Intercom Panel

Drawing Unit

mm

Drawing Scale

Not to scale

**DRAFT
SUBJECT TO
CHANGE**

Last Revised

Oct 09,2023

Drawing Version

V1.0

Page

1 of 10

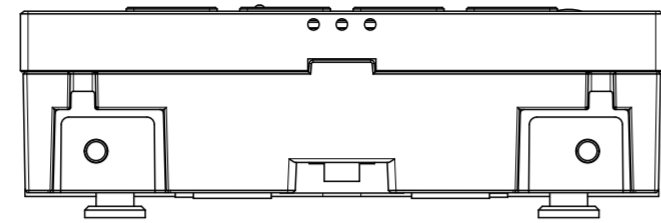

5 **TOP VIEW**

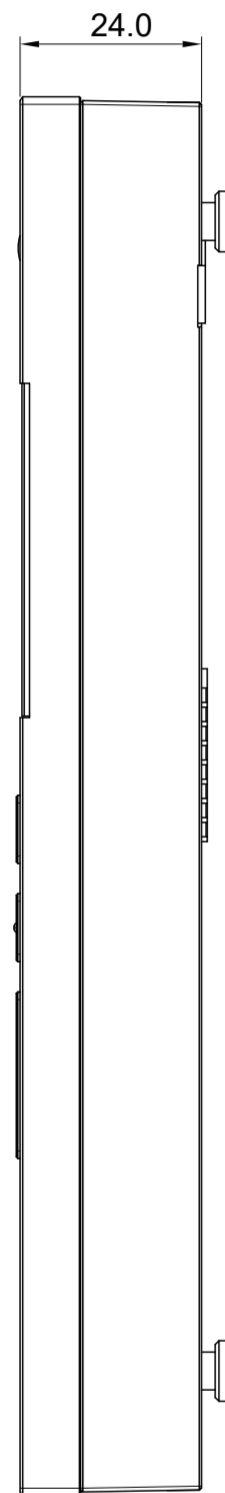

2 **RIGHT VIEW**

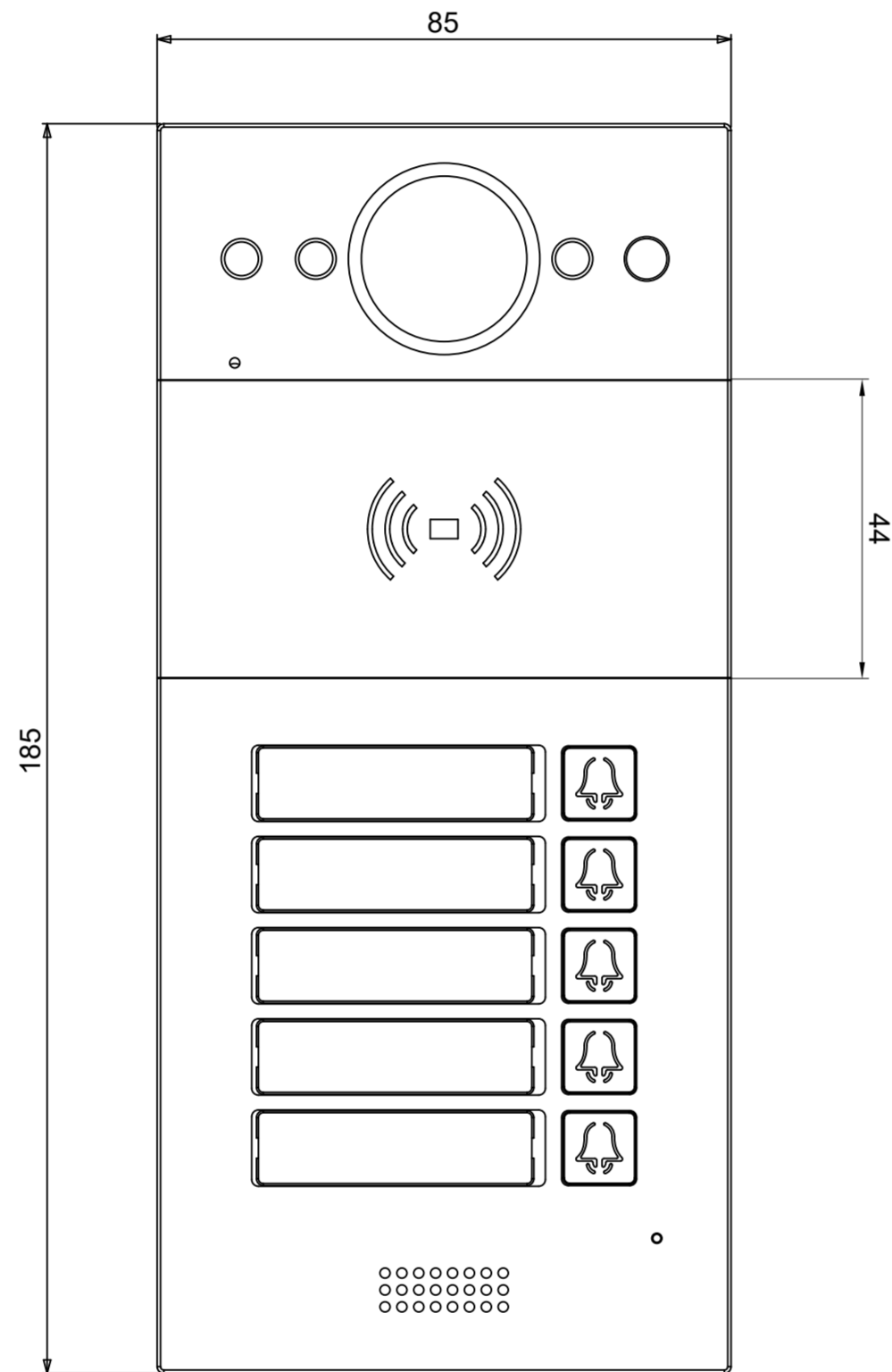

1 **FRONT VIEW**

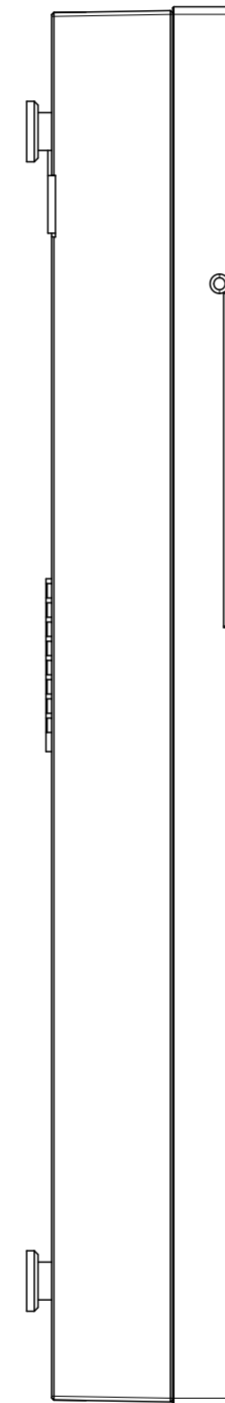

3 **LEFT VIEW**

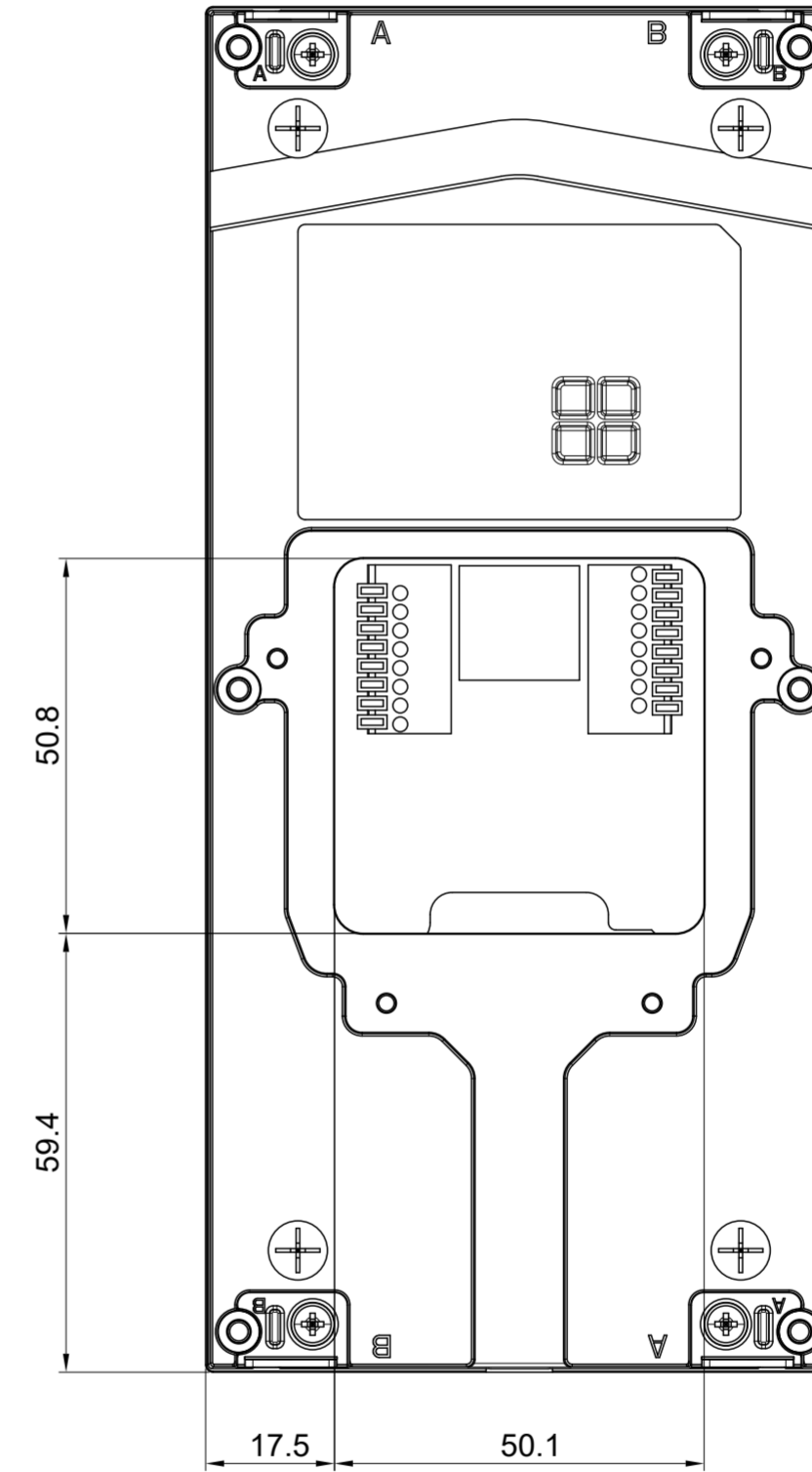

4 **BACK VIEW**

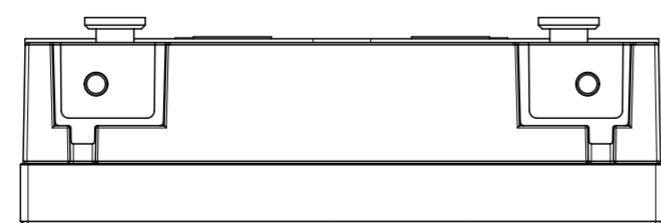

6 **BOTTOM VIEW**

Applicable Model

R20B

Drawing Title

Wall Mounting Bracket

Drawing Unit

mm

Drawing Scale

Not to scale

**DRAFT
SUBJECT TO
CHANGE**

Last Revised

Oct 09, 2023

Drawing Version

V1.0

Page

2 of 10

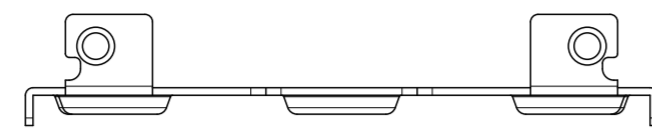

5 TOP VIEW

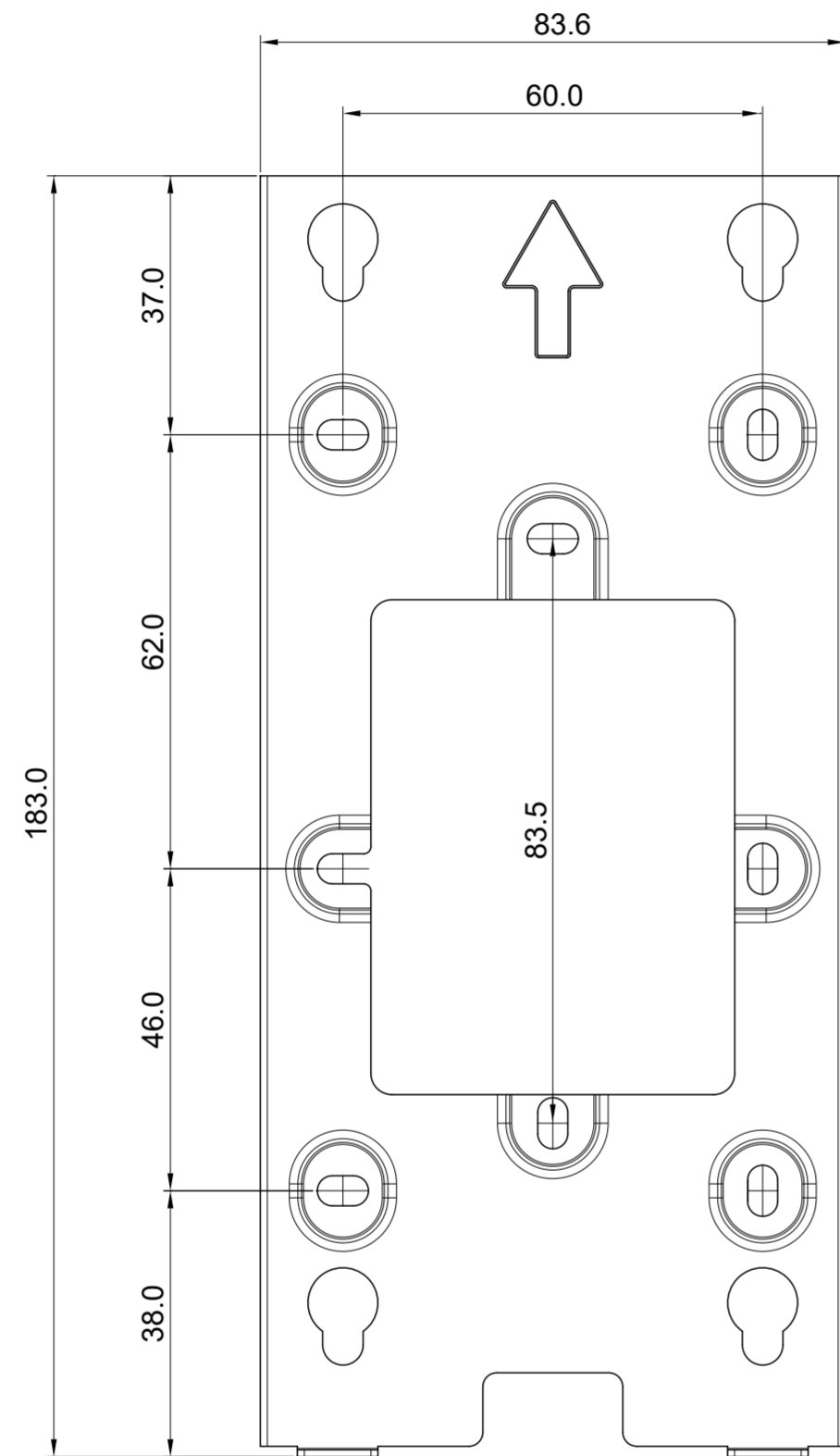

1 FRONT VIEW

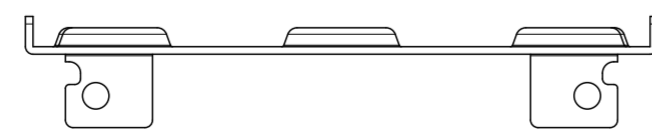

6 BOTTOM VIEW

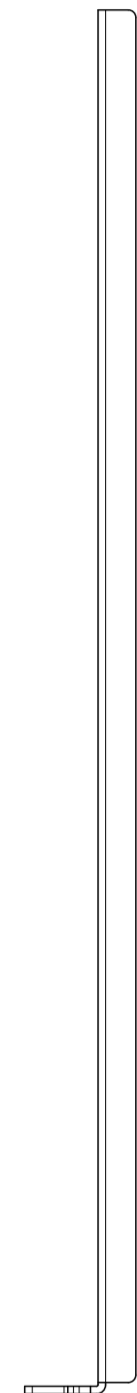

2 RIGHT VIEW

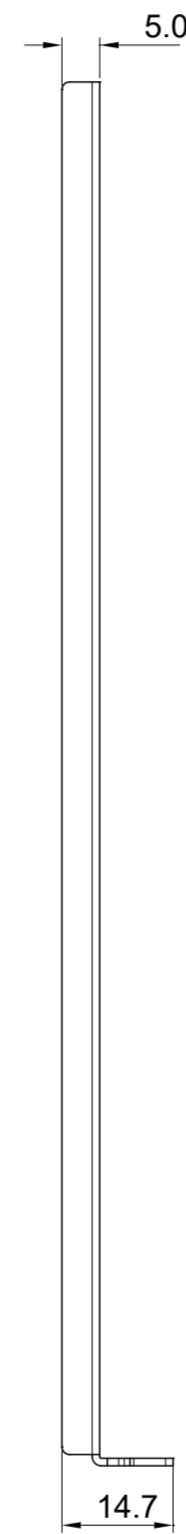

3 LEFT VIEW

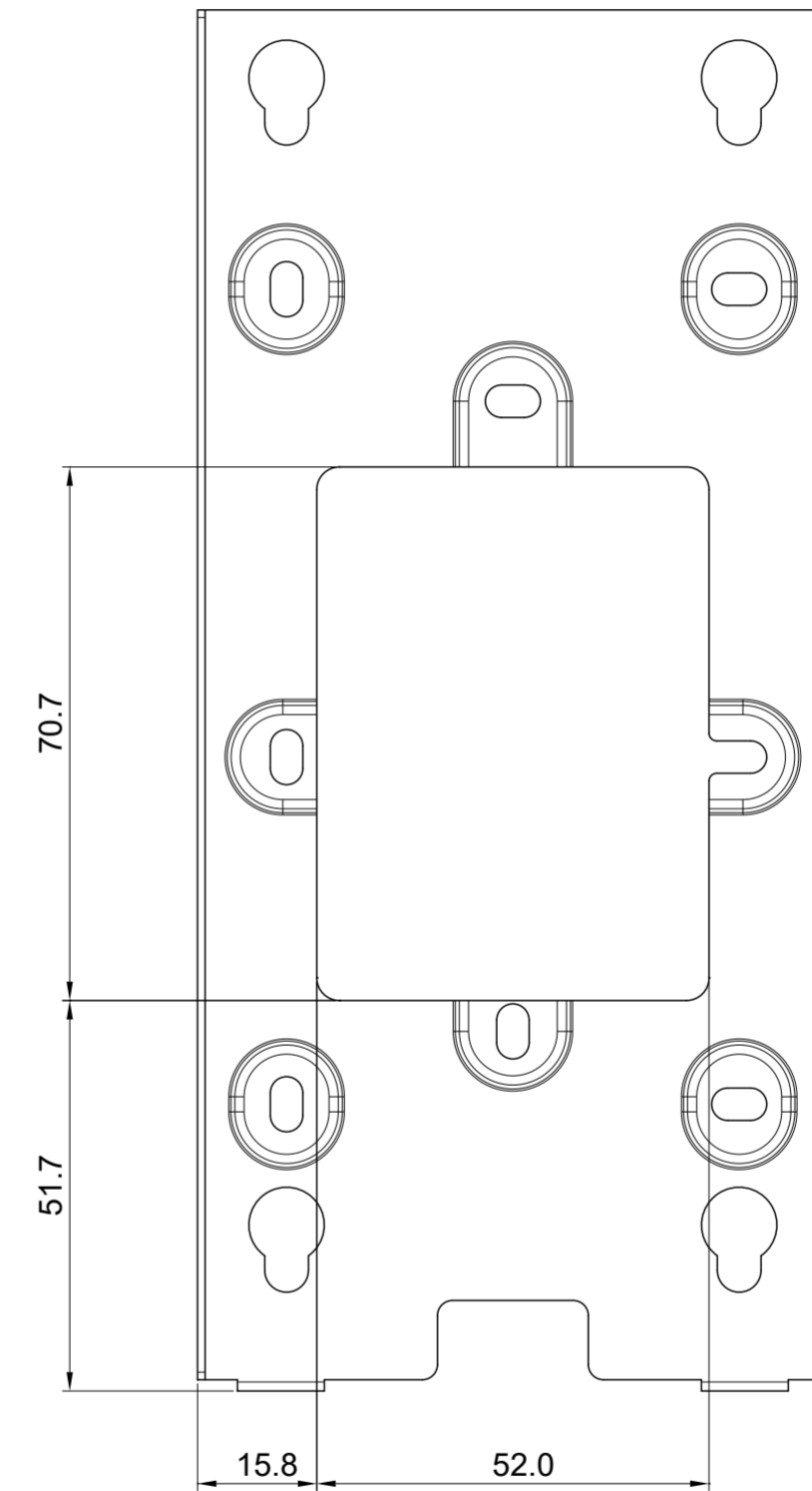

4 BACK VIEW

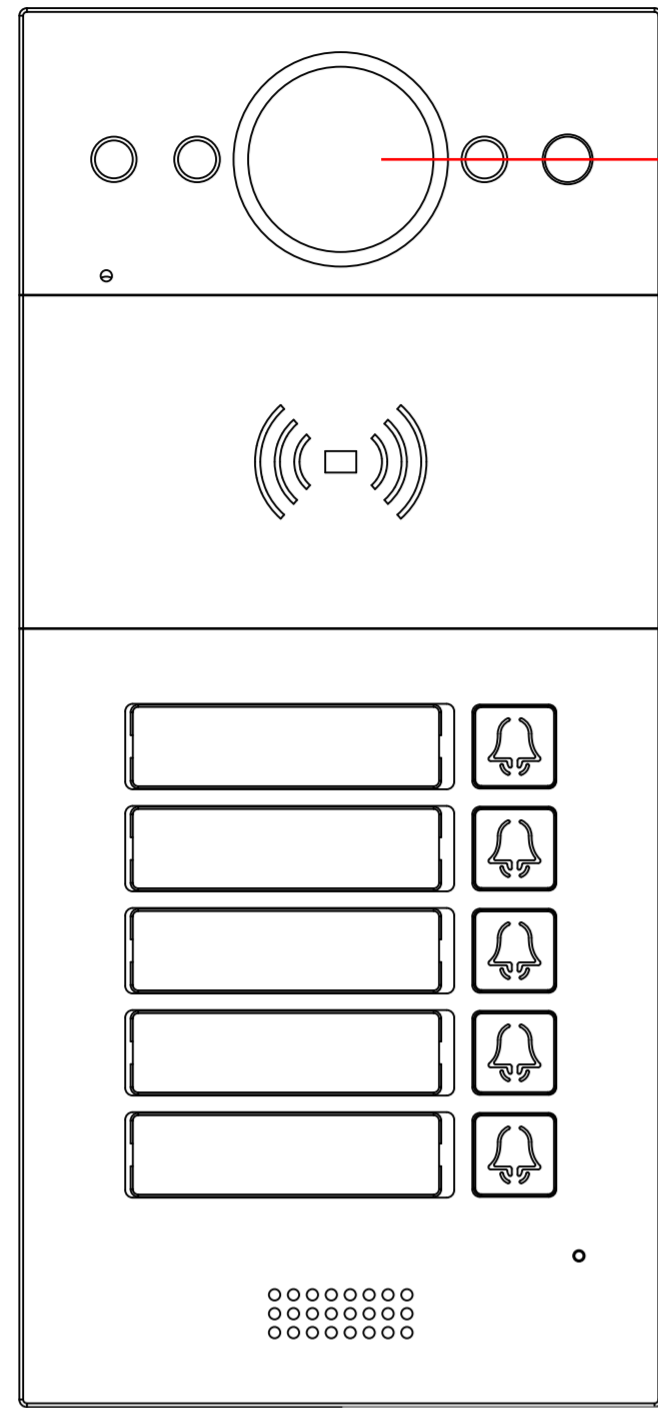

1 INTERCOM PANEL FRONT VIEW

1235mm TO BOTTOM OF PANEL

1400mm TO CENTER OF CAMERA

ADA Compliance Requirement

GROUND

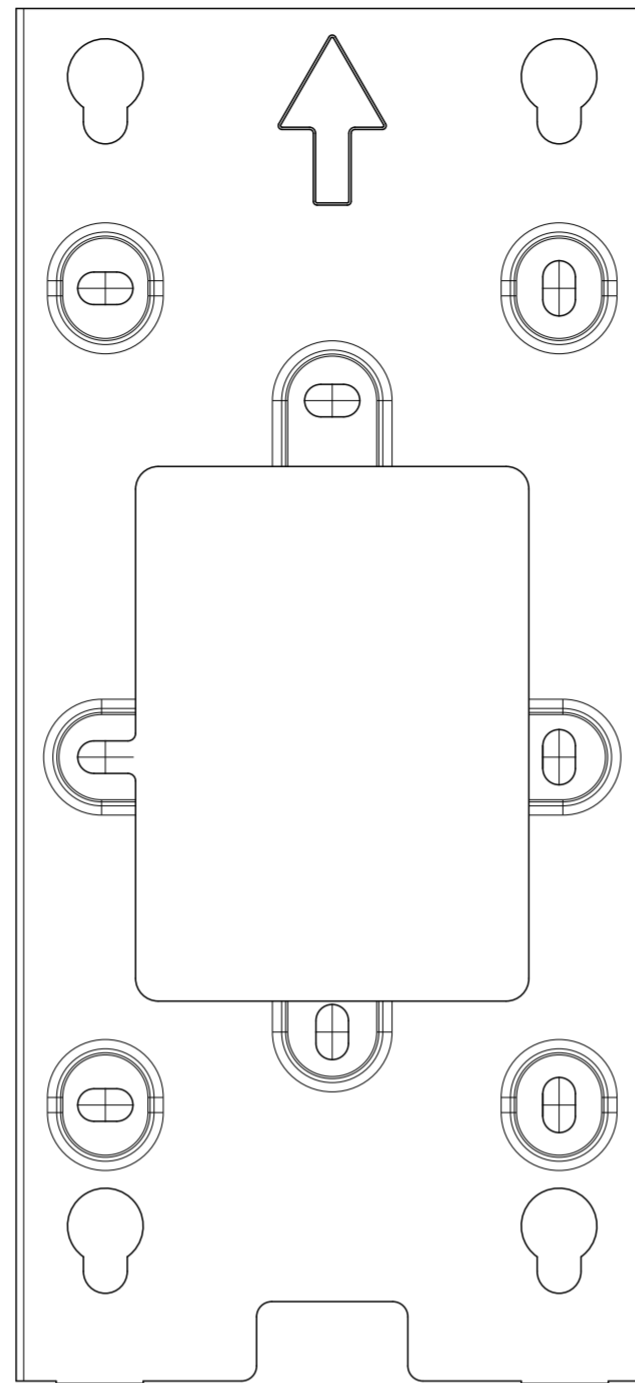

2 FRONT VIEW:WALL MOUNTING BRACKET PLACEMENT

1235mm TO BOTTOM OF BRACKET

GROUND

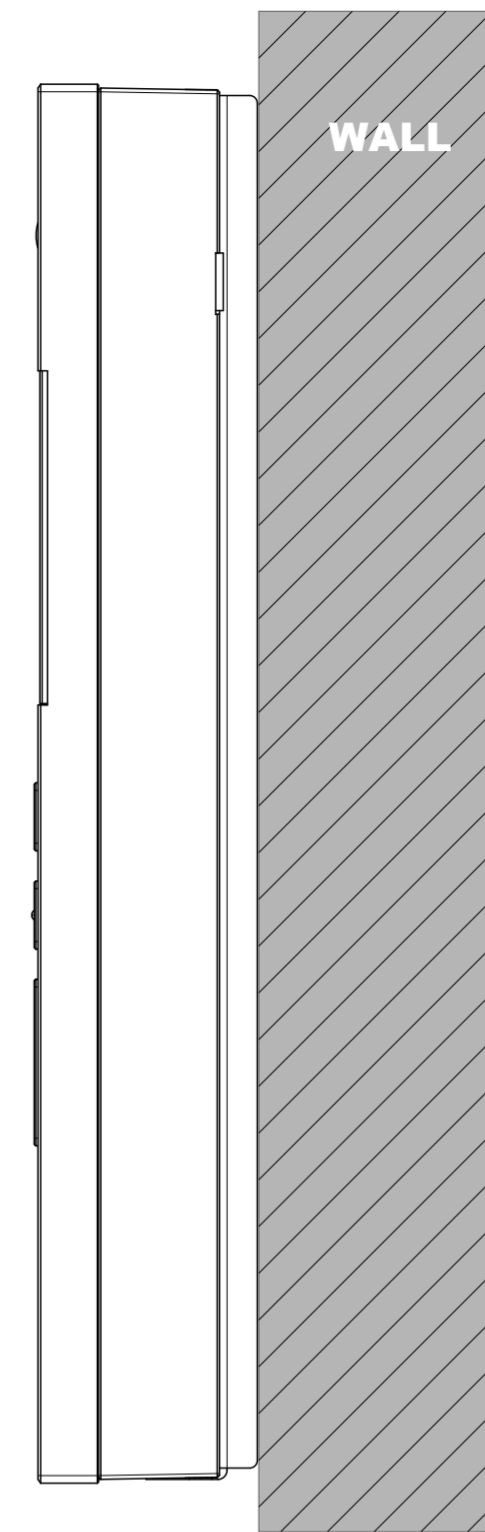

3 SIDE VIEW:INTERCOM PANEL ON WALL

Applicable Model

R20BX5

Drawing Title

Placement

Drawing Unit

mm

Drawing Scale

Not to scale

**DRAFT
SUBJECT TO
CHANGE**

Last Revised

Oct 09,2023

Drawing Version

V1.0

Page

3 of 10

Applicable Model

R20B

Drawing Title

On-Wall Mounting
Rain Cover

Drawing Unit

mm

Drawing Scale

Not to scale

**DRAFT
SUBJECT TO
CHANGE**

Last Revised

Oct 09,2023

Drawing Version

V1.0

Page

4 of 10

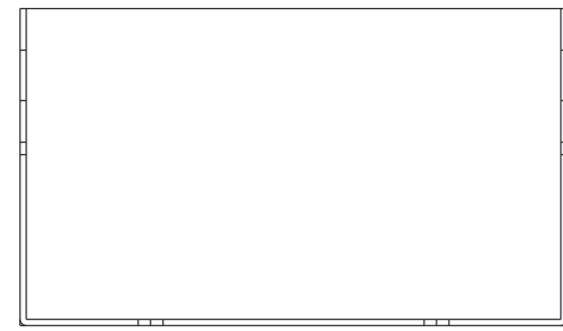

⑥ **BOTTOM VIEW**

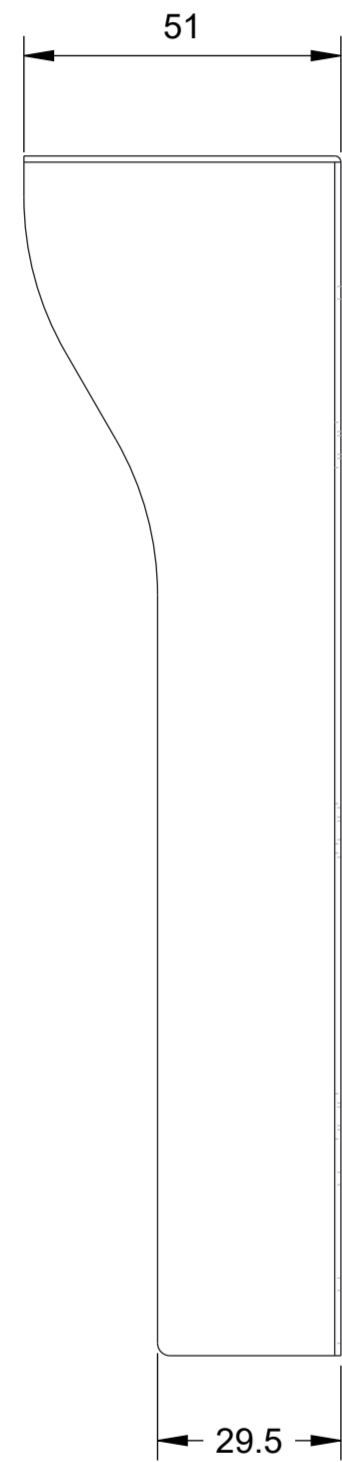

② **RIGHT VIEW**

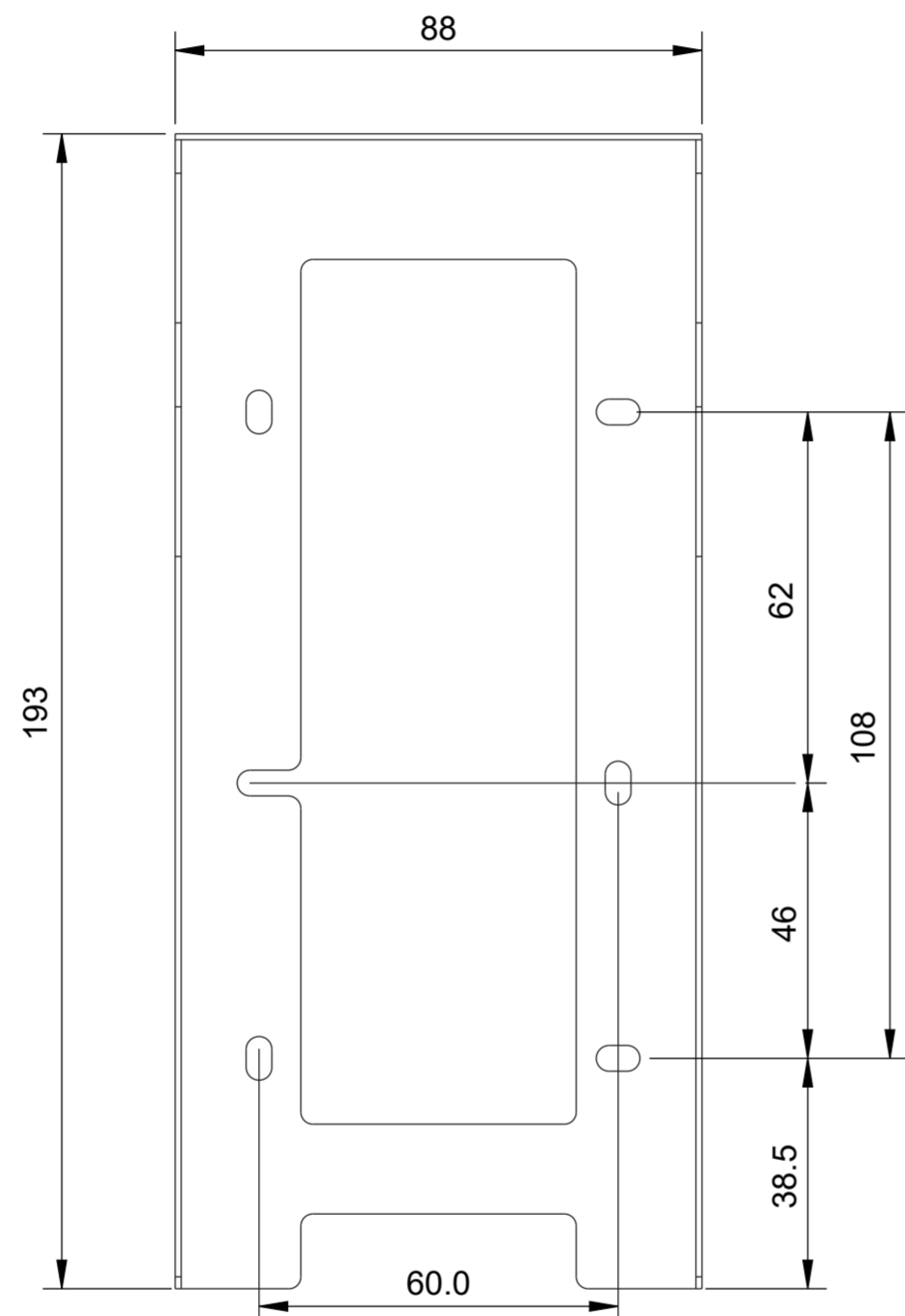

① **FRONT VIEW**

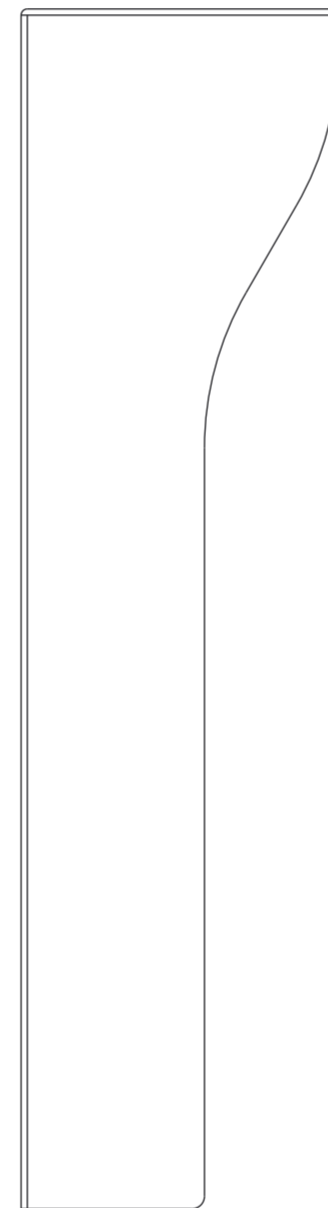

③ **LEFT VIEW**

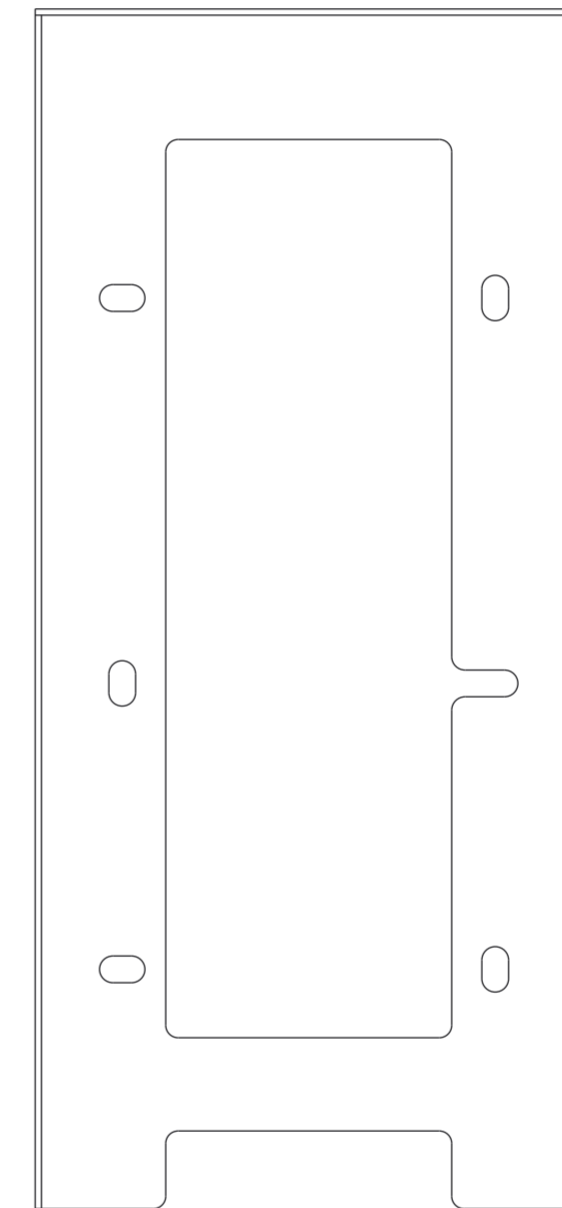

④ **BACK VIEW**



⑤ **TOP VIEW**

Applicable Model

R20BX5

Drawing Title

Placement

Drawing Unit

mm

Drawing Scale

Not to scale

**DRAFT
SUBJECT TO
CHANGE**

Last Revised

Oct 09,2023

Drawing Version

V1.0

Page

5 of 10

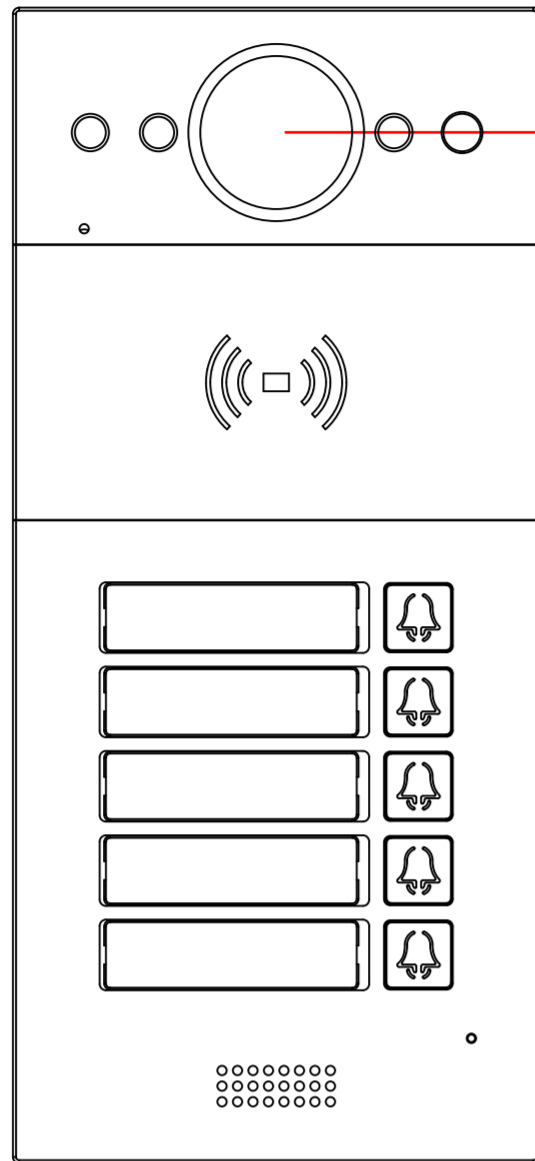

① INTERCOM PANEL FRONT VIEW

1235mm TO BOTTOM OF PANEL

1400mm TO CENTER OF CAMERA

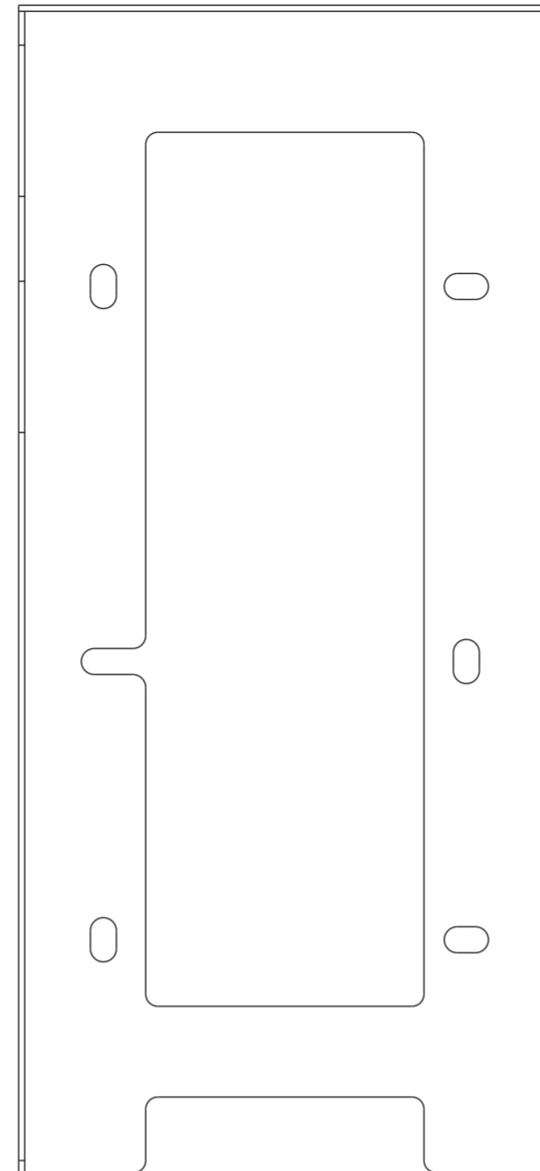

② FRONT VIEW:WALL MOUNTING BRACKET PLACEMENT

1235mm TO BOTTOM OF BRACKET

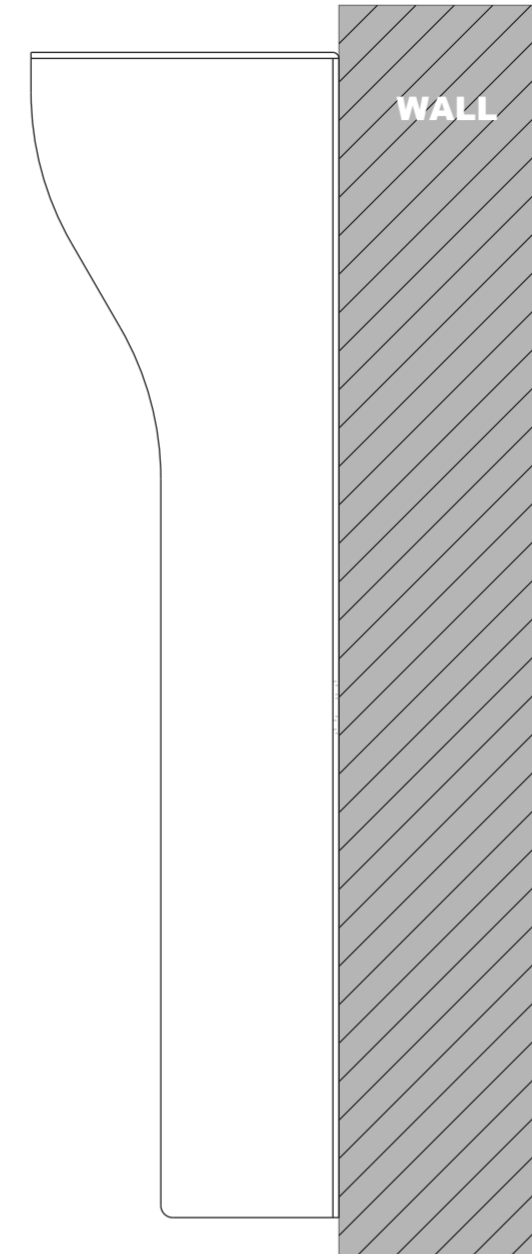

③ SIDE VIEW:INTERCOM PANEL ON WALL

ADA Compliance Requirement



GROUND

GROUND

Applicable Model

R20B

Drawing Title

Decorative Panel

Drawing Unit

mm

Drawing Scale

Not to scale

**DRAFT
SUBJECT TO
CHANGE**

Last Revised

Oct 09,2023

Drawing Version

V1.0

Page

6 of 10

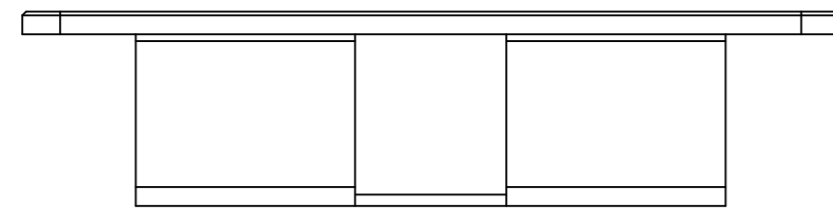

5 TOP VIEW

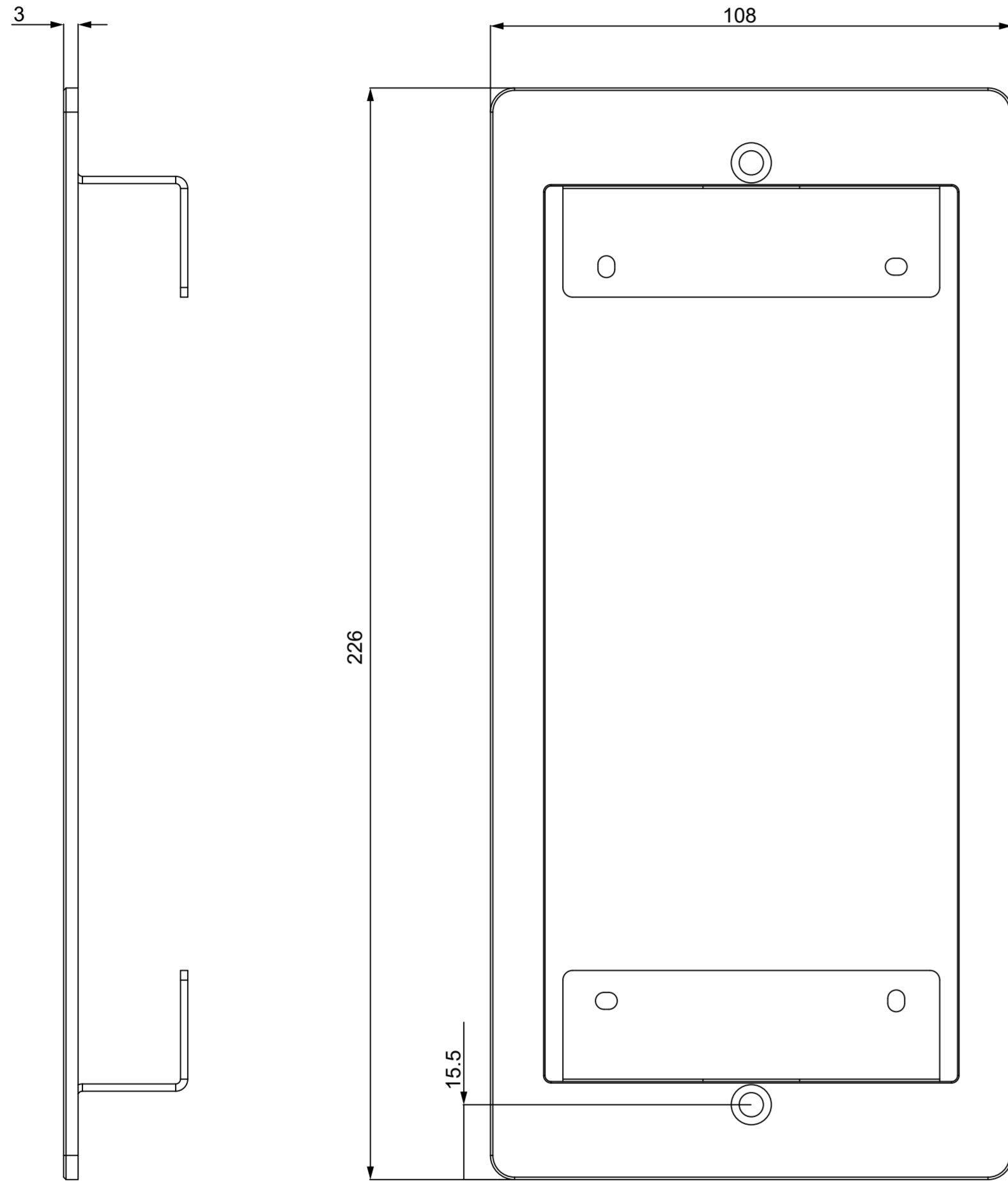

1 FRONT VIEW

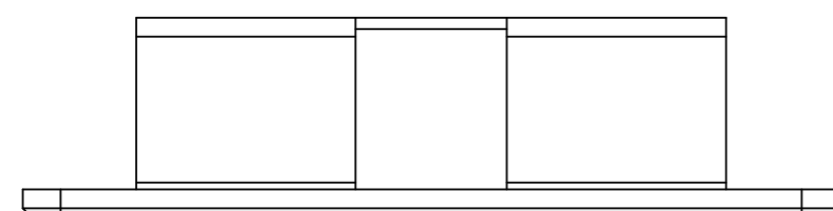

6 BOTTOM VIEW

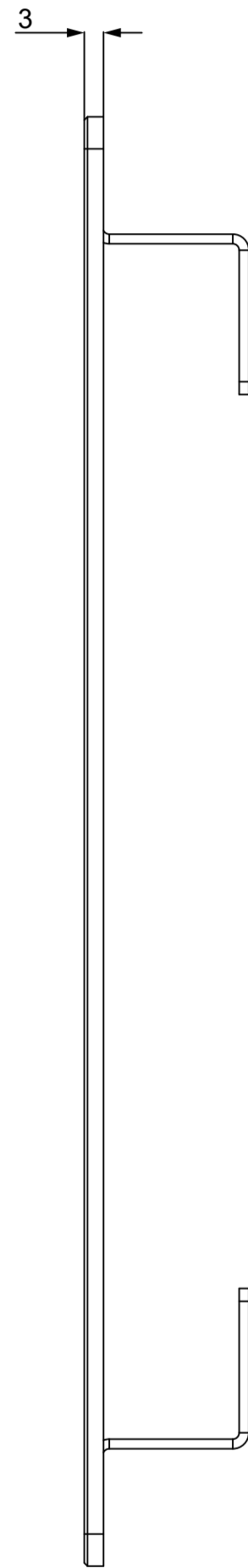

2 RIGHT VIEW

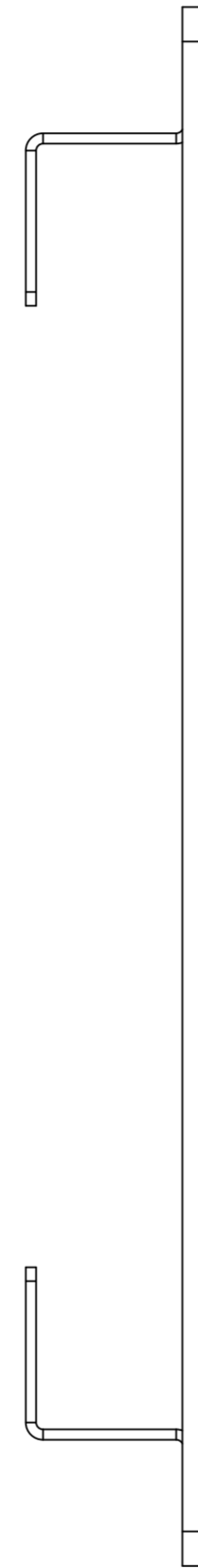

3 LEFT VIEW

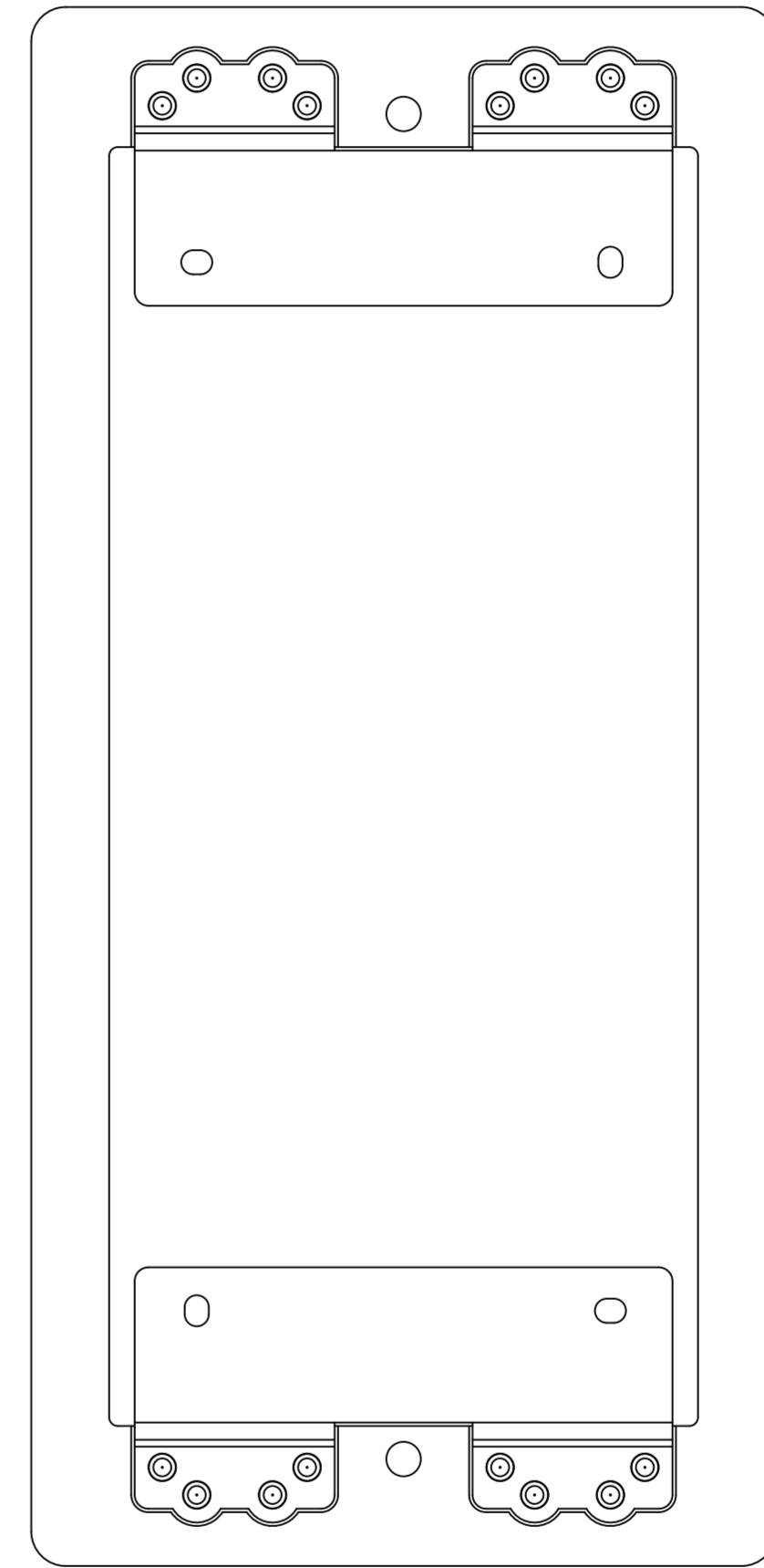

4 BACK VIEW

Applicable Model

R20B

Drawing Title

Flush Mounting Box

Drawing Unit

mm

Drawing Scale

Not to scale

**DRAFT
SUBJECT TO
CHANGE**

Last Revised

Oct 09,2023

Drawing Version

V1.0

Page

7 of 10

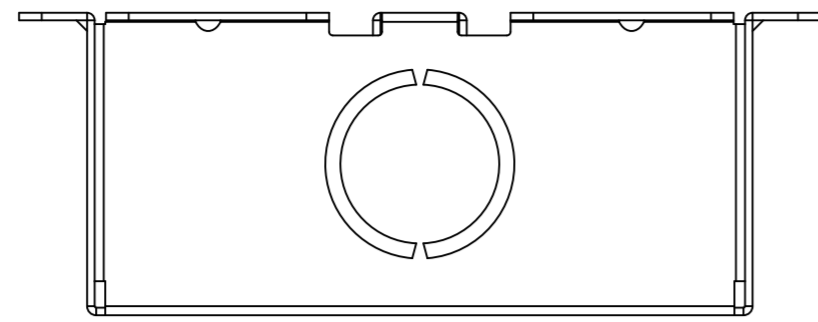

5 TOP VIEW

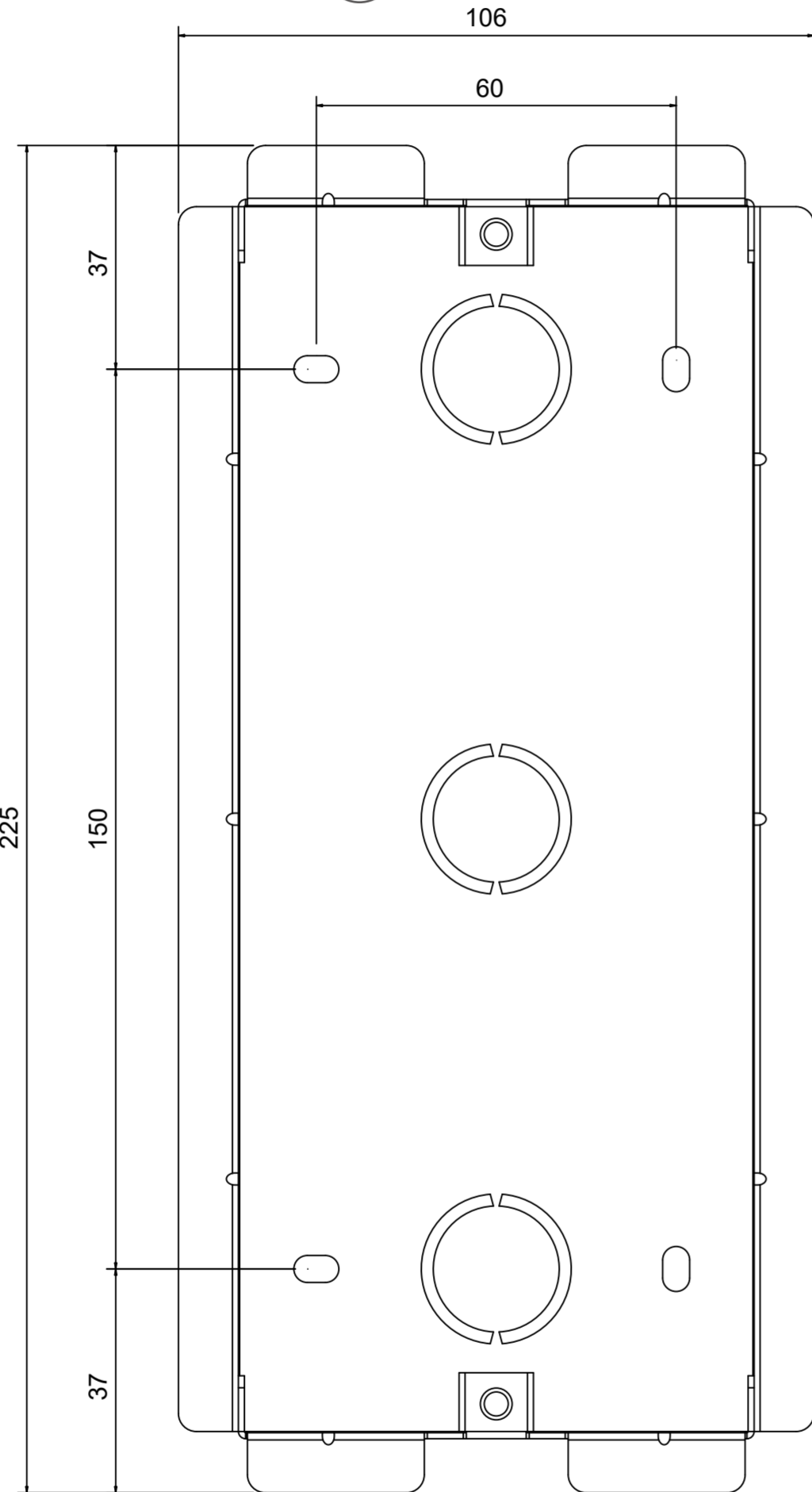

1 FRONT VIEW

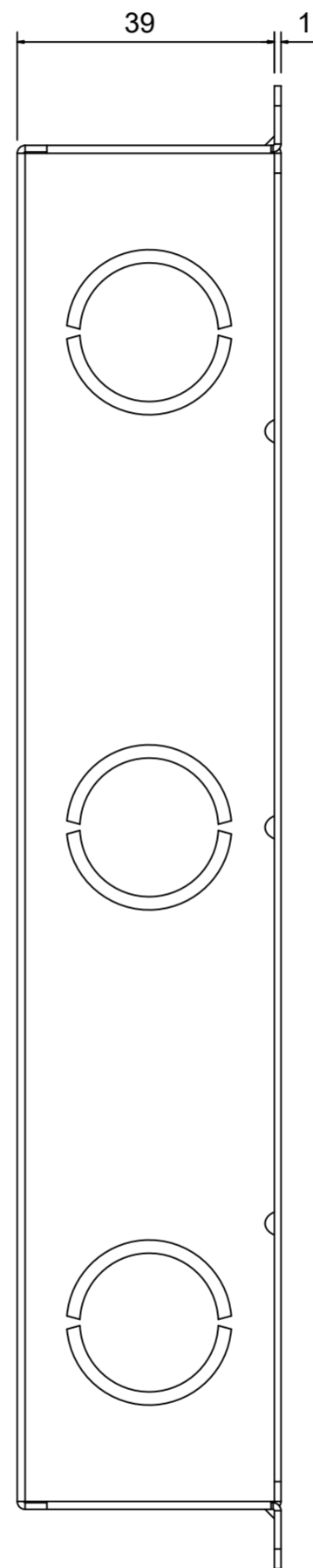

3 LEFT VIEW

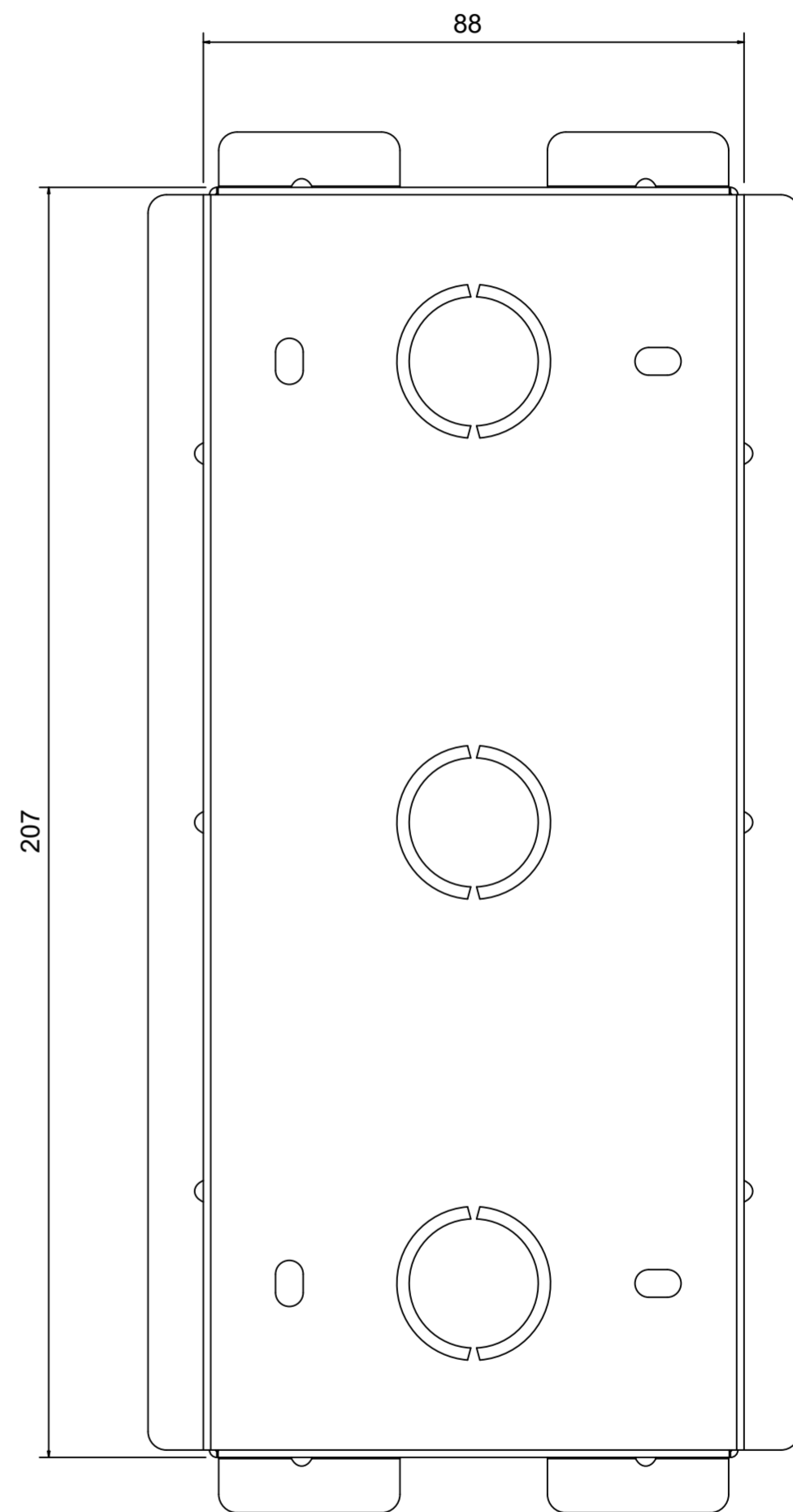

4 BACK VIEW

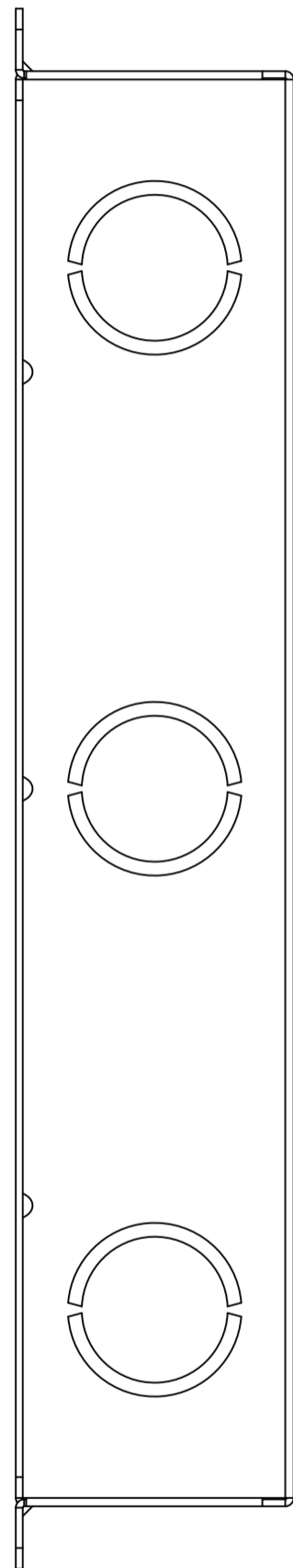

2 RIGHT VIEW

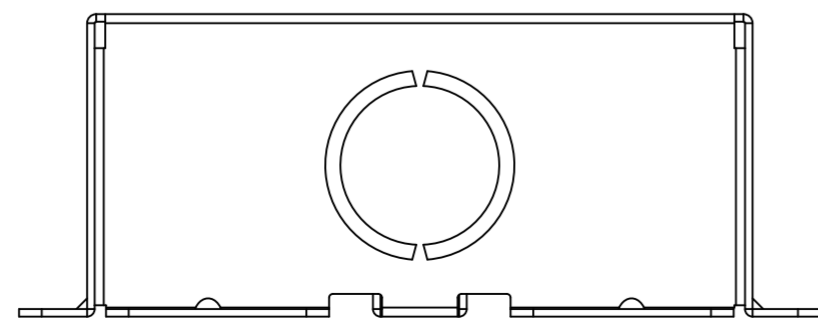

6 BOTTOM VIEW

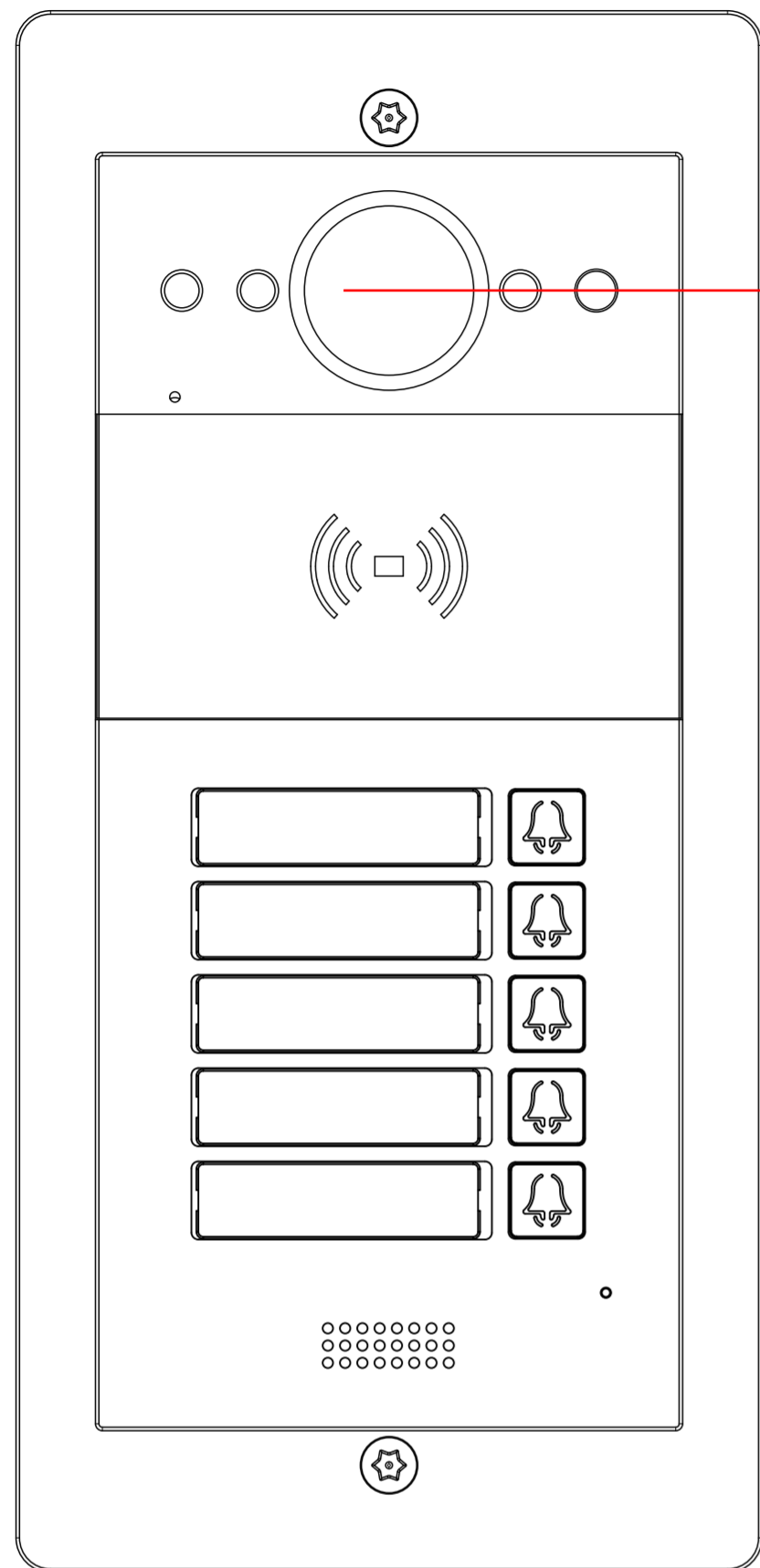

1 INTERCOM PANEL FRONT VIEW

1214.5mm TO BOTTOM OF BRACKET

1400mm TO CENTER OF CAMERA

ADA Compliance Requirement

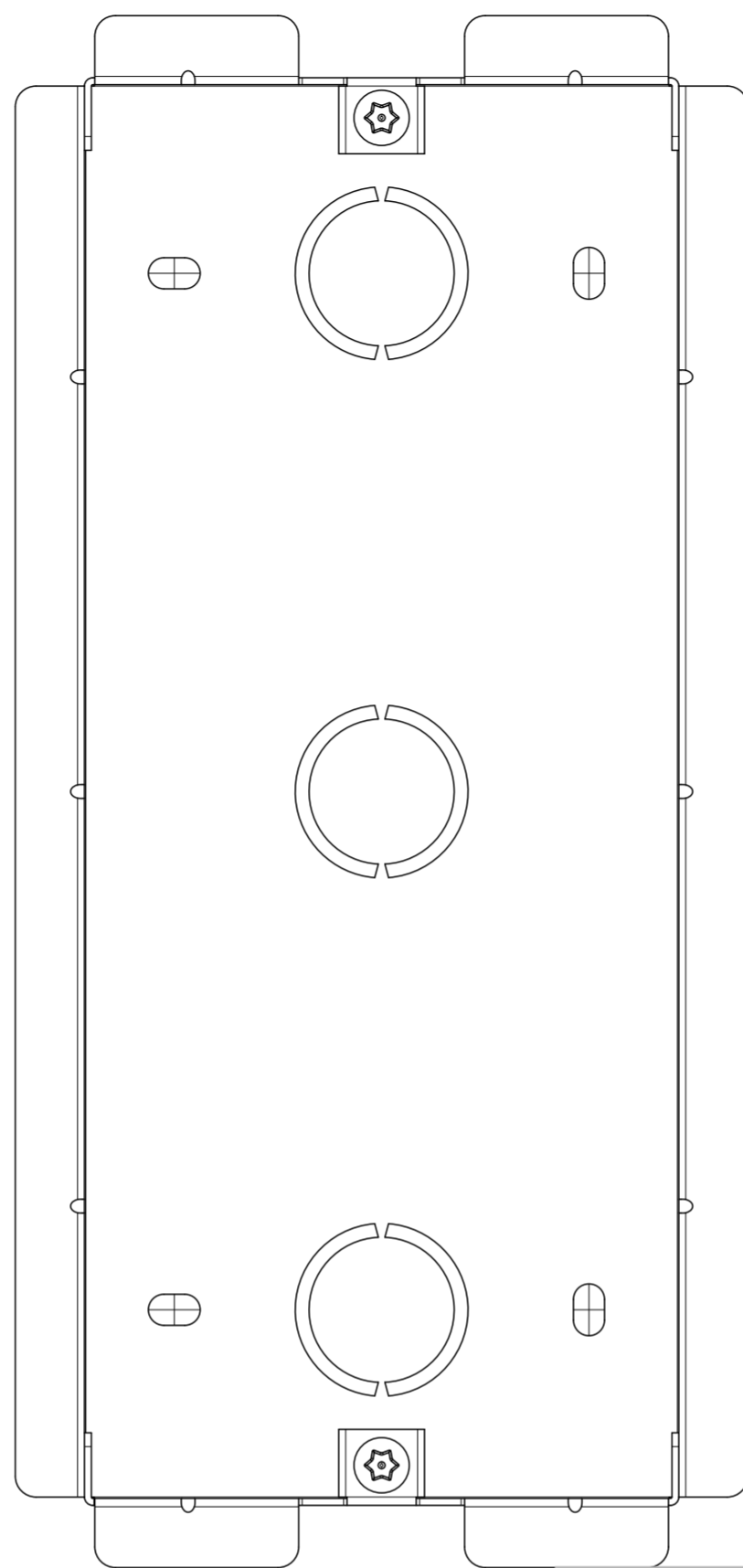

2 FRONT VIEW: FLUSHING MOUNTING BOX PLACEMENT

1215mm TO BOTTOM OF BRACKET

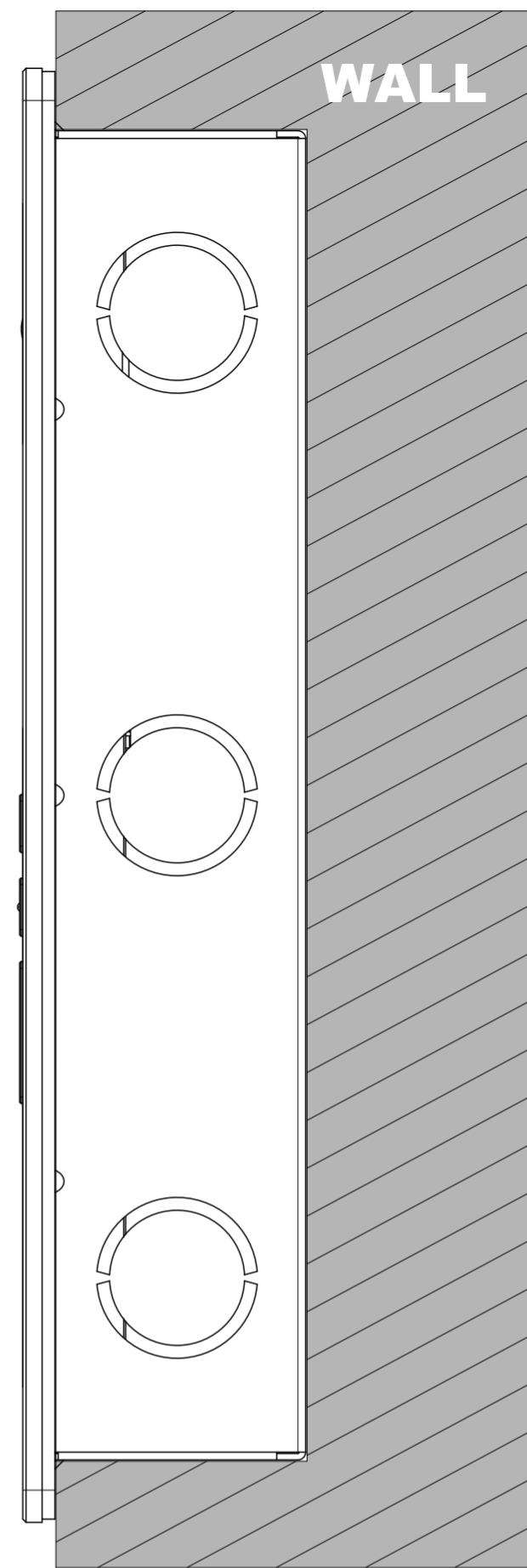
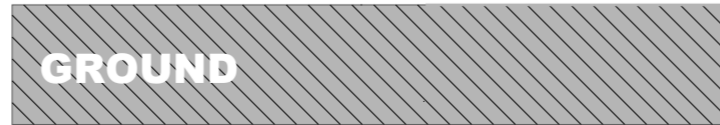

3 SIDE VIEW: INTERCOM PANEL IN WALL

Applicable Model

R20BX5

Drawing Title

Placement

Drawing Unit

mm

Drawing Scale

Not to scale

**DRAFT
SUBJECT TO
CHANGE**

Last Revised

Oct 09, 2023

Drawing Version

V1.0

Page

8 of 10

Applicable Model

R20B

Drawing Title

In-Wall Mounting
Rain Cover

Drawing Unit

mm

Drawing Scale

Not to scale

**DRAFT
SUBJECT TO
CHANGE**

Last Revised

Oct 09,2023

Drawing Version

V1.0

Page

9 of 10

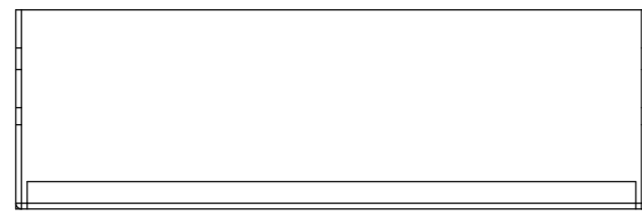

⑥ **BOTTOM VIEW**

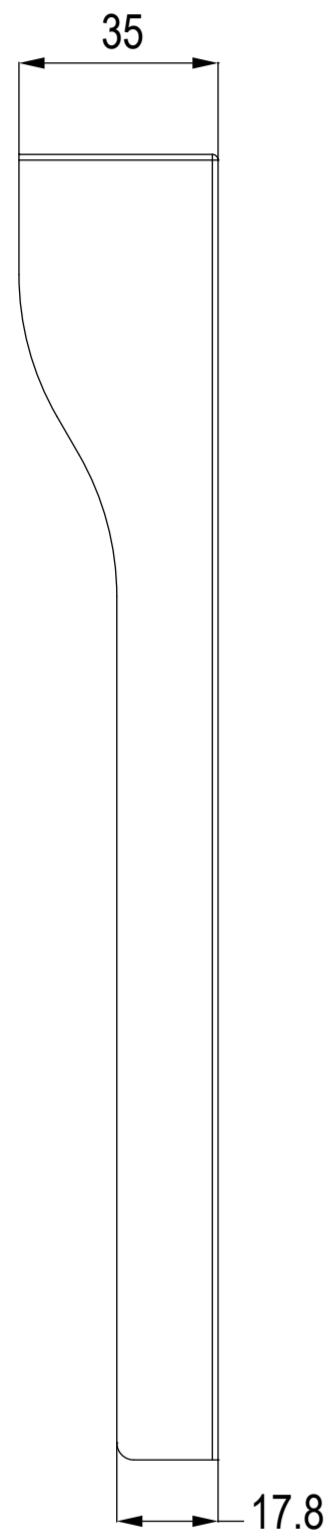

② **RIGHT VIEW**

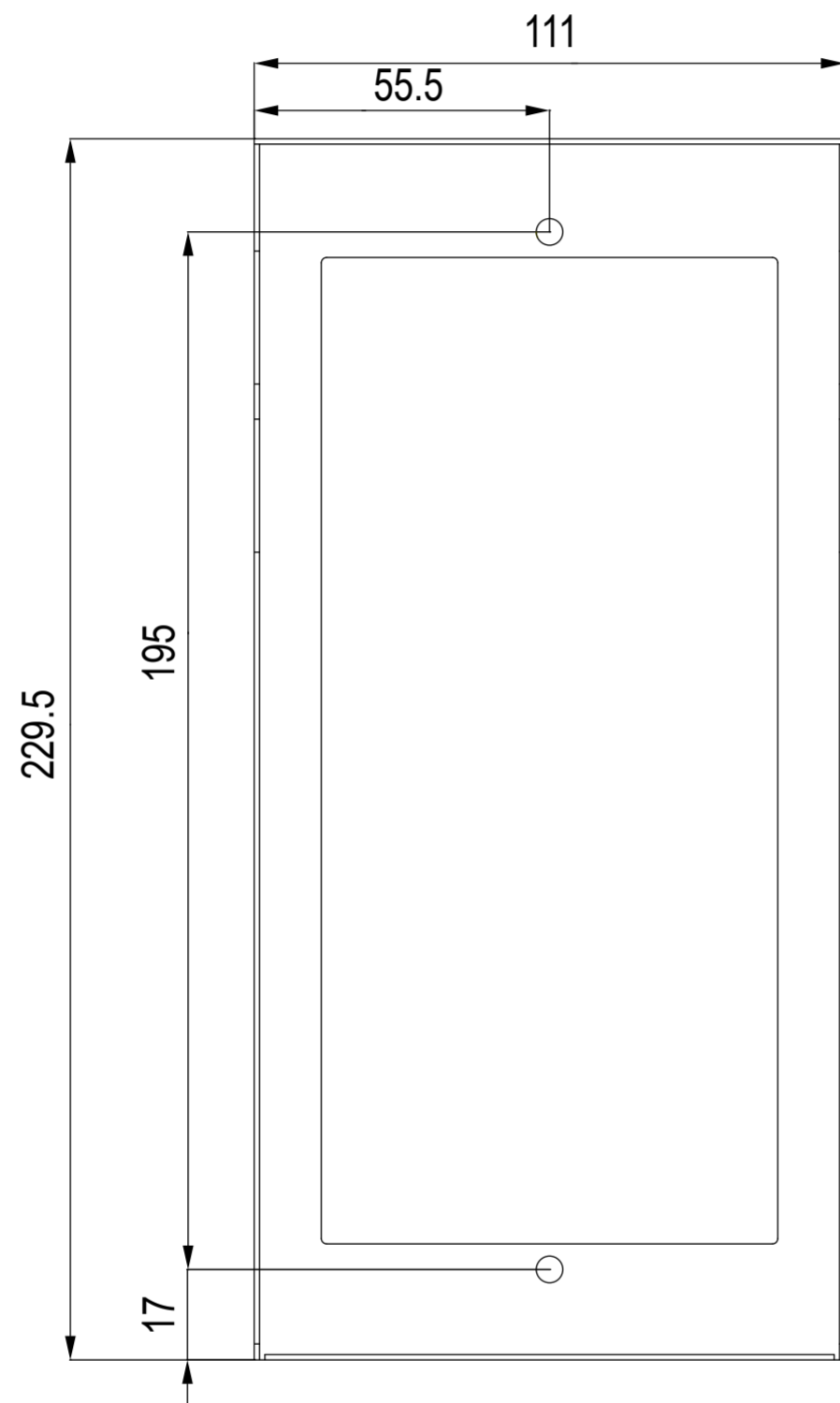

① **FRONT VIEW**



③ **LEFT VIEW**

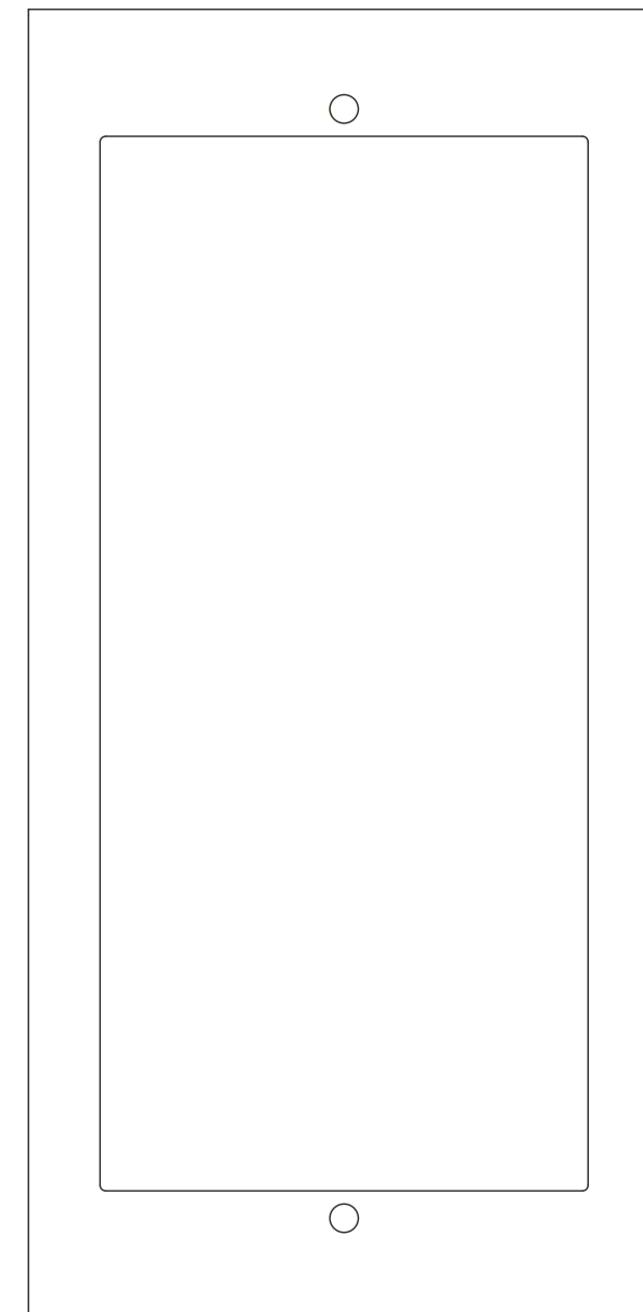

④ **BACK VIEW**

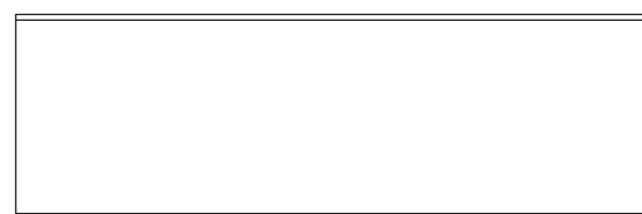

⑤ **TOP VIEW**

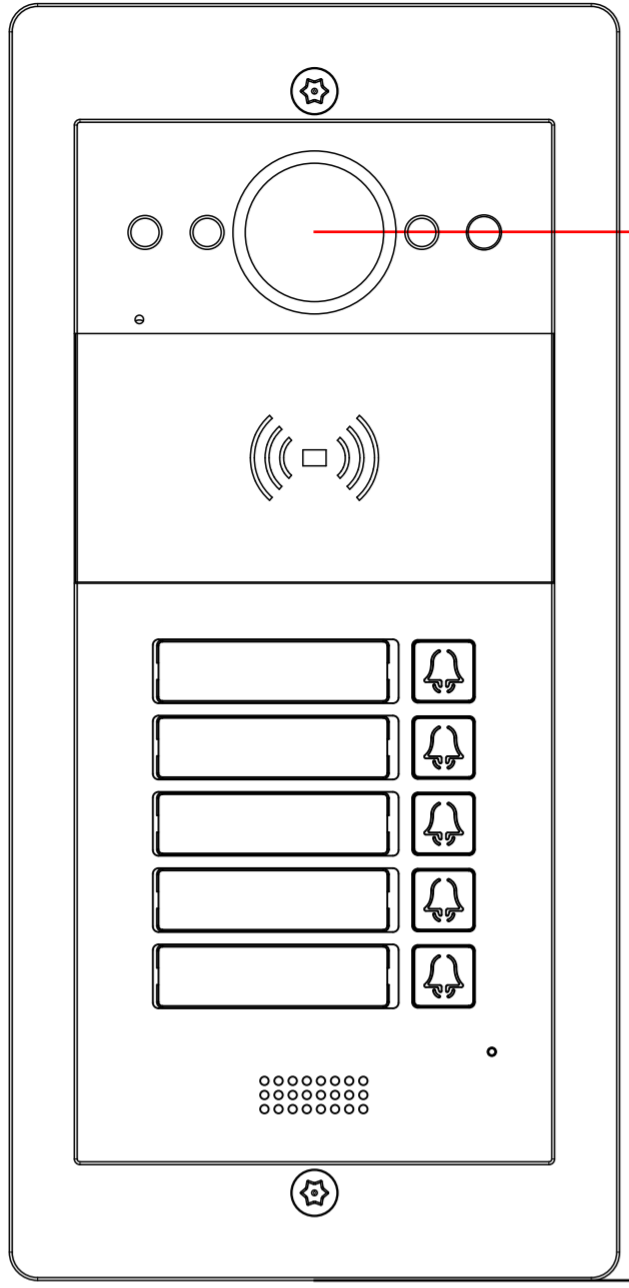

① INTERCOM PANEL FRONT VIEW

1214.5mm TO BOTTOM OF BRACKET

1400mm TO CENTER OF CAMERA

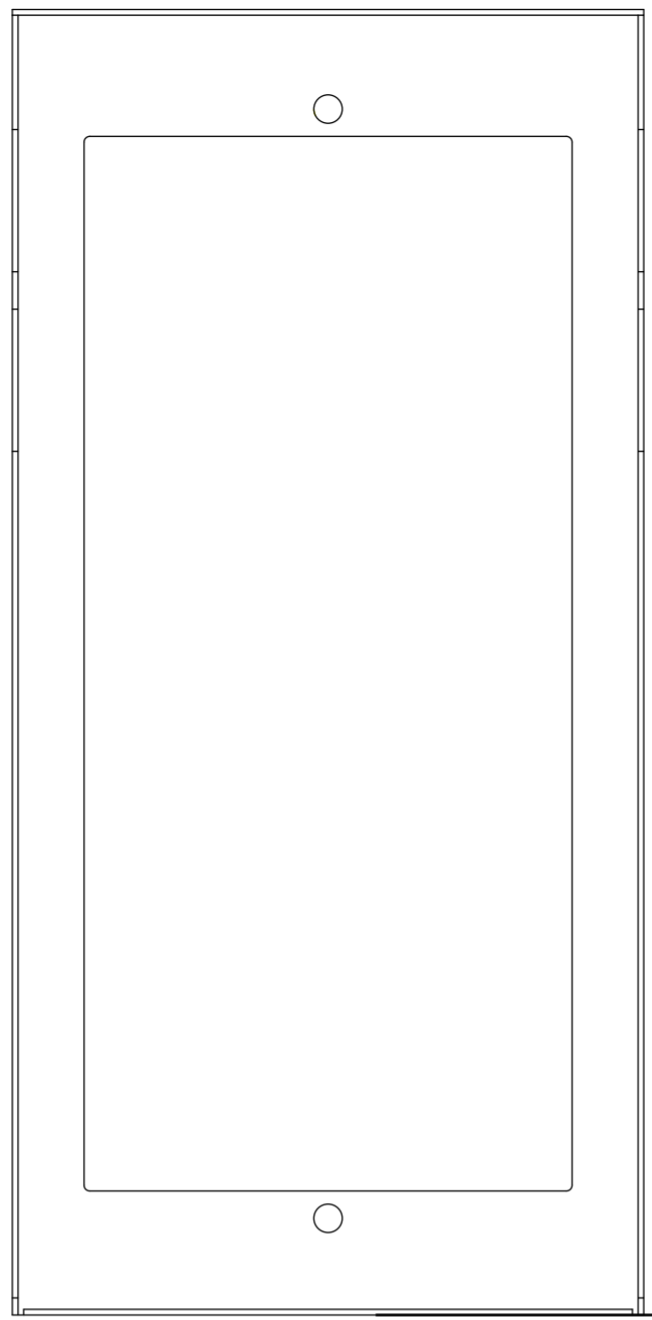

② FRONT VIEW:WALL MOUNTING BRACKET PLACEMENT

1213mm TO BOTTOM OF BRACKET

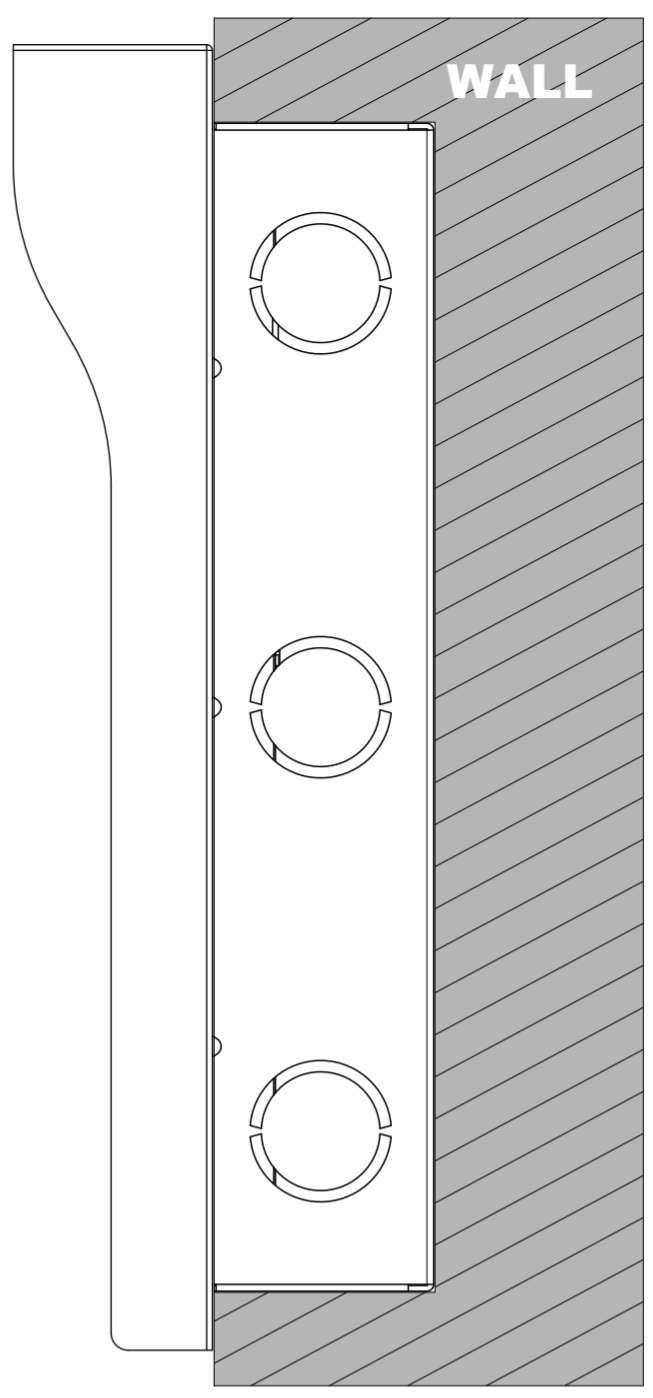

③ SIDE VIEW:INTERCOM PANEL IN WALL

ADA Compliance Requirement

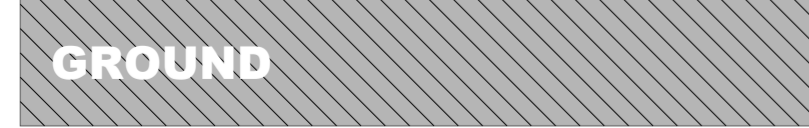

Applicable Model
R20BX5

Drawing Title
Placement

Drawing Unit
mm

Drawing Scale
Not to scale

**DRAFT
SUBJECT TO
CHANGE**

Last Revised
Oct 09,2023

Drawing Version
V1.0

Page
10 of 10